

---

**3-SPEED STEREO TURNTABLE  
2 CD MUSIC SYSTEM WITH CASSETTE  
AND AM/FM STEREO RADIO**



**USER MANUAL  
JTA-980C**

**PLEASE READ THIS USER MANUAL COMPLETELY BEFORE OPERATING THIS UNIT AND  
RETAIN THIS BOOKLET FOR FUTURE REFERENCE.**

## DEAR JENSEN® CUSTOMER

Selecting fine audio equipment such as the unit you've just purchased is only the start of your musical enjoyment. Now it's time to consider how you can maximize the fun and excitement your equipment offers. This manufacturer and the Electronic Industries Association's Consumer Electronics Group want you to get the most out of your equipment by playing it at a safe level. One that lets the sound come through loud and clear without annoying blaring or distortion and, most importantly, without affecting your sensitive hearing.

Sound can be deceiving. Over time your hearing "comfort level" adapts to higher volumes of sound. So what sounds "normal" can actually be loud and harmful to your hearing. Guard against this by setting your equipment at a safe level BEFORE your hearing adapts.

### **To establish a safe level:**

- Start your volume control at a low setting.
- Slowly increase the sound until you can hear it comfortably and clearly, and without distortion.

### **Once you have established a comfortable sound level:**

- Set the dial and leave it there.

Taking a minute to do this now will help to prevent hearing damage or loss in the future. After all, we want you listening for a lifetime.

### **We Want You Listening For a Lifetime**

Used wisely, your new sound equipment will provide a lifetime of fun and enjoyment. Since hearing damage from loud noise is often undetectable until it is too late, this manufacturer and the Electronic Industries Association's Consumer Electronics Group recommend you avoid prolonged exposure to excessive noise.

### **Customer's Record:**

The serial number of this product is found on its back cover. You should note the serial number of this unit in the space provided as a permanent record of your purchase to aid in identification in the event of theft or loss.

**Model Number: JTA-980C**

**Serial Number: \_\_\_\_\_**

## WARNING:

TO REDUCE THE RISK OF FIRE OR ELECTRIC SHOCK, DO NOT EXPOSE THIS APPLIANCE TO RAIN OR MOISTURE. DANGEROUS HIGH VOLTAGES ARE PRESENT INSIDE THE ENCLOSURE. DO NOT OPEN THE CABINET REFER SERVICING TO QUALIFIED PERSONNEL ONLY.

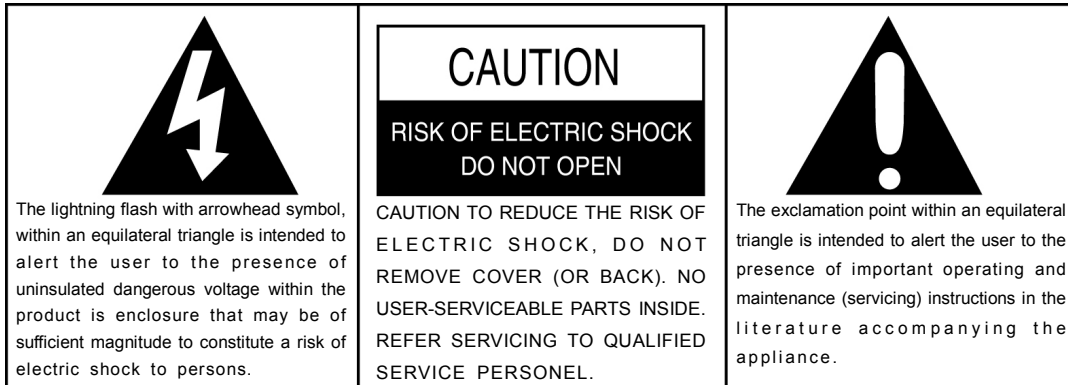

**THE CAUTION MARKING IS LOCATED AT THE BACK OF THE UNIT  
THE RATING PLATE IS LOCATED AT THE BACK OF THE UNIT**

## CAUTION:

**PLEASE READ AND OBSERVE ALL WARNINGS AND INSTRUCTIONS GIVEN IN THIS USER MANUAL AND THOSE MARKED ON THE UNIT. RETAIN THIS BOOKLET FOR FUTURE REFERENCE.**

THIS SET HAS BEEN DESIGNED AND MANUFACTURED TO ASSURE PERSONAL SAFETY. IMPROPER USE CAN RESULT IN ELECTRIC SHOCK OR FIRE HAZARD. THE SAFEGUARDS INCORPORATED IN THIS UNIT WILL PROTECT YOU IF YOU OBSERVE THE FOLLOWING PROCEDURES FOR INSTALLATION, USE AND SERVICING. THIS UNIT DOES NOT CONTAIN ANY PARTS THAT CAN BE REPAIRED BY THE USER.



THE SYMBOL FOR CLASS II (DOUBLE INSULATION)

**DO NOT REMOVE THE CABINET COVER OR YOU MAY BE EXPOSED TO DANGEROUS VOLTAGE. REFER SERVICING TO QUALIFIED SERVICE PERSONNEL ONLY.**

# IMPORTANT SAFETY INSTRUCTIONS

1. READ THESE INSTRUCTIONS.
2. KEEP THESE INSTRUCTIONS.
3. HEED ALL WARNINGS.
4. FOLLOW ALL INSTRUCTIONS.
5. DO NOT USE THIS APPARATUS NEAR WATER.

6. CLEAN ONLY WITH A DRY CLOTH.
7. DO NOT BLOCK ANY OF THE VENTILATION OPENINGS. INSTALL IN ACCORDANCE WITH THE MANUFACTURER'S INSTRUCTIONS.
8. DO NOT INSTALL NEAR ANY HEAT SOURCES SUCH AS RADIATORS, HEAT REGISTERS, STOVES, OR OTHER APPARATUS (INCLUDING AMPLIFIERS) THAT PRODUCE HEAT.
9. DO NOT DEFEAT THE SAFETY PURPOSE OF THE POLARIZED OR GROUNDING – TYPE PLUG. A POLARIZED PLUG HAS TWO BLADES WITH ONE WIDER THAN THE OTHER. A GROUNDING TYPE PLUG HAS TWO BLADES AND A THIRD GROUNDING PRONG. THE WIDE BLADE OR THE THIRD PRONG IS PROVIDED FOR YOUR SAFETY. IF THE PROVIDED PLUG DOES NOT FIT INTO YOUR OUTLET, CONSULT AN ELECTRICIAN FOR REPLACEMENT OF THE OBSOLETE OUTLET.
10. PROTECT THE POWER CORD FROM BEING WALKED ON OR PINCHED PARTICULARLY AT PLUGS, CONVENIENCE RECEPTACLES AND THE POINT WHERE THEY EXIT FROM THE APPARATUS.
11. ONLY USE ATTACHMENTS/ACCESSORIES SPECIFIED BY THE MANUFACTURER.
12. USE ONLY WITH A CART, STAND, TRIPOD, BRACKET, OR TABLE SPECIFIED BY THE MANUFACTURER, OR SOLD WITH THE APPARATUS. WHEN A CART IS USED, USE CAUTION WHEN MOVING THE CART/APPARATUS COMBINATION TO AVOID INJURY FROM TIP-OVER.
13. UNPLUG THIS APPARATUS DURING LIGHTNING STORMS OR WHEN UNUSED FOR LONG PERIODS OF TIME.
14. POWER SOURCES - THE APPLIANCE SHOULD BE CONNECTED TO A POWER SUPPLY ONLY OF THE TYPE DESCRIBED IN THE OPERATING INSTRUCTIONS OR AS MARKED ON THE APPLIANCE. DO NOT OVERLOAD WALL OUTLET.
15. WALL AND CEILING MOUNTING - THE APPLIANCE SHOULD BE MOUNTED TO A WALL OR CEILING ONLY AS RECOMMENDED BY THE MANUFACTURER.
16. POWER LINES - AN OUTDOOR ANTENNA SHOULD BE LOCATED AWAY FROM POWER LINES.
17. OUTDOOR ANTENNA GROUNDING - IF AN OUTSIDE ANTENNA IS CONNECTED TO THE RECEIVER, BE SURE THE ANTENNA SYSTEM IS GROUNDED SO AS TO PROVIDE SOME PROTECTION AGAINST VOLTAGE SURGES AND BUILT UP STATIC CHARGES. SECTION 810 OF THE NATIONAL ELECTRICAL CODE, ANSI/ NFPA NO.70-1984, PROVIDES INFORMATION WITH RESPECT TO PROPER GROUNDING OF THE MAST AND SUPPORTING STRUCTURE, GROUNDING OF THE LEAD-IN WIRE TO AN ANTENNA DISCHARGE UNIT, SIZE OF GROUNDING CONDUCTORS, LOCATION OF ANTENNA DISCHARGE UNIT, CONNECTION TO GROUNDING ELECTRODES, AND REQUIREMENTS FOR THE GROUNDING ELECTRODE. SEE FIGURE 1.



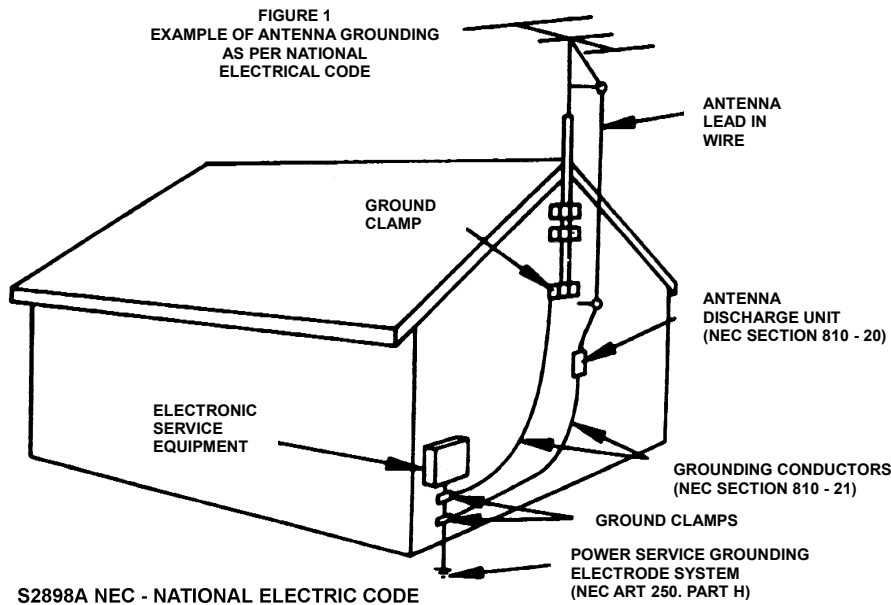

18. OBJECT AND LIQUID ENTRY - CARE SHOULD BE TAKEN SO THAT OBJECTS DO NOT FALL AND LIQUIDS ARE NOT SPILLED INTO THE ENCLOSURE THROUGH OPENINGS.
19. REFER ALL SERVICING TO QUALIFIED SERVICE PERSONNEL. SERVICING IS REQUIRED WHEN THE APPARATUS HAS BEEN DAMAGED IN ANYWAY, SUCH AS POWER-SUPPLY CORD OR PLUG IS DAMAGED, LIQUID HAS BEEN SPILLED OR OBJECTS HAVE FALLEN INTO THE APPARATUS, THE APPARATUS HAS BEEN EXPOSED TO RAIN OR MOISTURE, DOES NOT OPERATE NORMALLY OR HAS BEEN DROPPED.
20. THE APPARATUS SHALL NOT BE EXPOSED TO DRIPPING OR SPLASHING AND THAT NO OBJECTS FILLED WITH LIQUIDS, SUCH AS VASES, SHALL BE PLACED ON APPARATUS.
21. MAINS PLUG IS USED AS DISCONNECT DEVICE AND IT SHOULD REMAIN READILY OPERABLE DURING INTENDED USE. IN ORDER TO DISCONNECT THE APPARATUS FROM THE MAINS COMPLETELY, THE MAINS PLUG SHOULD BE DISCONNECTED FROM THE MAINS SOCKET OUTLET COMPLETELY.
22. BATTERY PACK OR BATTERY INSTALLED SHOULD NOT BE EXPOSED TO EXCESSIVE HEAT SUCH AS SUNSHINE, FIRE OR THE LIKE.
23. DANGER OF EXPLOSION IF BATTERY IS INCORRECTLY REPLACED. REPLACE ONLY WITH THE SAME OR EQUIVALENT TYPE.

## CAUTION:

**TO PREVENT ELECTRIC SHOCK, MATCH WIDE BLADE OF PLUG TO WIDE SLOT. FULLY INSERT THE PLUG TO MAIN POWER SOCKET.**

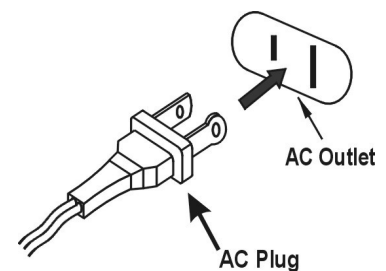

# CAUTION

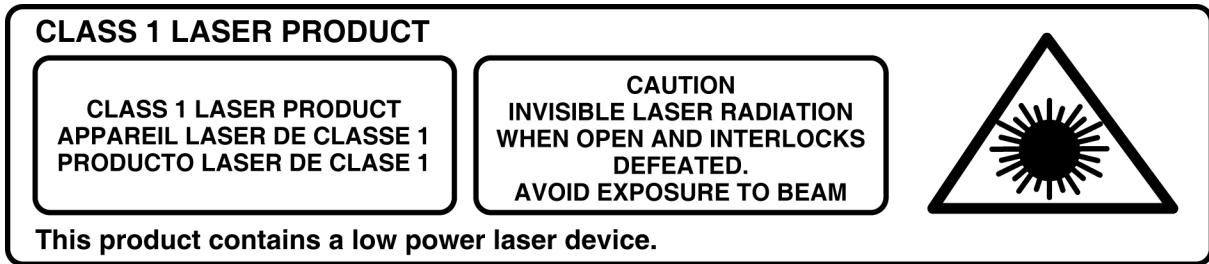

**Note:** CLASS 1 LASER PRODUCT. THIS PRODUCT COMPLIES WITH DHHS RULE 21 CFR, SUBCHAPTER J, PART 1040 AT THE DATE OF MANUFACTURE.

Follow the advice below for safe and appropriate operation.

## **ON PROTECTION AGAINST LASER ENERGY EXPOSURE**

- As the laser beam used in this compact disc player is harmful to the eyes, do not attempt to disassemble the casing.
- Stop operation immediately if any liquid or solid object should fall into the cabinet.
- Do not touch the lens or poke at it. If you do, you may damage the lens and the player may not operate properly.
- Do not put anything in the safety slot. If you do, the laser diode will be ON when the CD door is still open.
- This unit employs a laser. The use of controls or adjustment or performance of procedures other than those specified here may result in exposure to hazardous radiation.

### **Caution:**

- Any use of the controls or performing any of the procedures in a way other than those specified herein may result in hazardous radiation exposure.
- This unit should not be adjusted or repaired by anyone except qualified service personnel.

## **ON PLACEMENT**

- Do not use the unit in places which are extremely hot, cold, dusty or humid.
- Place the unit on a flat and even surface.
- Do not restrict the air-flow of the unit by placing it in a place with poor ventilation, by covering it with a cloth or by placing it on a carpet.

## **ON CONDENSATION**

- When left in a heated room where it is warm and damp, water droplets or condensation may form inside the unit.
- When there is condensation inside the unit, the unit may not function normally. Let it stand for 1 to 2 hours before turning the power on, or gradually heat the room up and dry the unit before use.

Should any trouble occur, remove the power source and refer servicing to qualified personnel.

## **PRECAUTION FOR USE**

- **UNPACK ALL PARTS AND REMOVE PROTECTIVE MATERIAL.**
- **DO NOT CONNECT THE UNIT TO THE MAINS BEFORE CHECKING THE MAINS VOLTAGE AND ALL OTHER CONNECTIONS HAVE BEEN MADE.**

- **DO NOT COVER ANY VENTS AND MAKE SURE THAT THERE IS A SPACE OF SEVERAL CENTIMETERS AROUND THE UNIT FOR VENTILATION.**

## **IMPORTANT NOTES**

Avoid installing the unit in locations described below:

- Places exposed to direct sunlight or close to heat radiating appliances such as electric heaters.
- Places subject to constant vibration.
- Dusty, humid or moist places.

## **COMPLIANCE WITH FCC REGULATIONS**

This device complies with Part 15 of the FCC Rules. Operation is subject to the following two conditions:

- (1) this device may not cause harmful interference, and
- (2) this device must accept any interference received, including interference that may cause undesired operation.

NOTE : This equipment has been tested and found to comply with the limits for a Class B digital device, pursuant to Part 15 of the FCC Rules. These limits are designed to provide reasonable protection against harmful interference in a residential installation. This equipment generates, uses and can radiate radio frequency energy and, if not installed and used in accordance with the instructions, may cause harmful interference to radio communications. However, there is no guarantee that interference will not occur in a particular installation. If this equipment does cause harmful interference to radio or television reception, which can be determined by turning the equipment off and on, the user is encouraged to try to correct the interference by one or more of the following measures:

- Reorient or relocate the receiving antenna.
- Increase the separation between the equipment and receiver.
- Connect the equipment into an outlet on a circuit different from that to which the receiver is connected.
- Consult the dealer or an experienced radio/TV technician for help.

**CAUTION: Changes or modifications not expressly approved by the party responsible for compliance could void the user's authority to operate the equipment.**

## **PROTECT YOUR FURNITURE!!**

This system is equipped with non-skid rubber 'feet' to prevent the product from moving when you operate the controls. These 'feet' are made from non-migrating rubber material specially formulated to avoid leaving any marks or stains on your furniture. However certain types of oil based furniture polishes, wood preservatives, or cleaning sprays may cause the rubber 'feet' to soften, and leave marks or a rubber residue on the furniture.

To prevent any damage to your furniture we strongly recommend that you purchase small self-adhesive felt pads, available at hardware stores and home improvement centers everywhere, and apply these pads to the bottom of the rubber 'feet' before you place the product on fine wooden furniture.

## GETTING STARTED

### SPEAKER CONNECTION

1. Insert the speaker cable ends (exposed wires) into the terminals located on the back of the main unit by pushing down the lever of the left speaker terminal and then the right speaker terminal
2. Connect the left speaker to the left speaker terminals with the red wire to L+ and the black wire to L -.
3. Connect the right speaker to the right speaker terminals with the red wire to R+ and the black wire to R -.

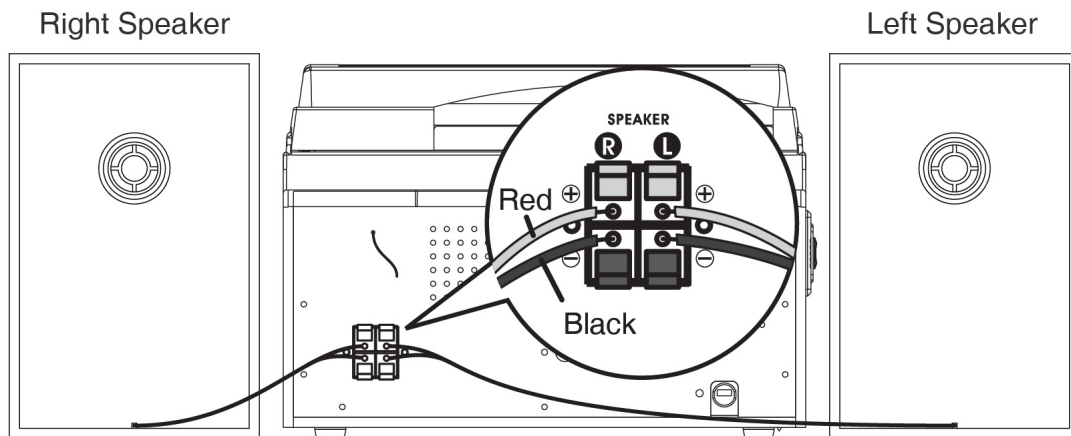

### NOTE:

Make sure that the power is turned off when connecting or disconnecting the speakers. Make sure that the speakers are connected to the correct terminals.

### CONNECTING THE AC POWER CORD

After connecting the speakers unwind the AC power cord fully and connect it to any convenient household 120V~ 60Hz AC outlet

### NOTE:

The product is designed to operate on normal 120V~ 60Hz AC only. Connecting this system to any other power supply could result in damage to the unit which is not covered by your warranty. You will noted that this system is equipped with a polarized AC power plug having one blade wider than the other. This is a safety feature.



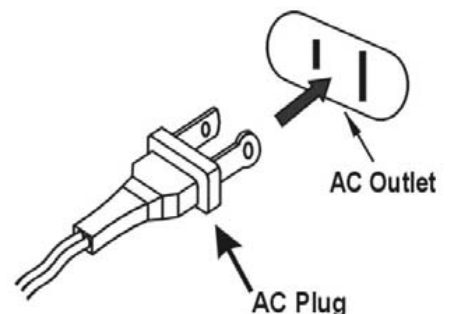









If this plug does not fit into your existing AC outlet, do not try to defeat this safety feature by filing the wide blade to make it fit into your outlet. If this plug will not fit into your outlet, you probably have an outdated non-polarized AC outlet. You should have your outlet changed by a qualified licensed electrician.





# LOCATION OF CONTROLS AND INDICATORS

## MAIN UNIT

- 1) TURNTABLE DUST COVER
- 2) LCD DISPLAY
- 3) REMOTE SENSOR
- 4) STANDBY MODE LED INDICATOR
- 5) MEMORY/CLOCK ADJUST BUTTON
- 6) CD 1 PLAY MODE BUTTON
- 7) RADIO PRESET UP (CHANNEL+) BUTTON
- 8) **CD1** – CD TRAY OPEN/CLOSE  BUTTON
- 9) **CD1** – CD PLAY/PAUSE / AM/FM BAND BUTTON
- 10) **CD1** – CD STOP / FM STEREO/MONO BUTTON
- 11) **CD1** – CD/RADIO SKIP/TUNE UP / DOWN  BUTTON
- 12) **CD1** – CD TRAY
- 13) SLEEP/WAKE UP TIMER BUTTON
- 14) CD 2 TRACK SEPARATION BUTTON
- 15) POWER ON /STANDBY BUTTON
- 16) FUNCTION BUTTON
- 17) EQ BUTTON
- 18) ROTARY VOLUME CONTROL KNOB
- 19) FINALIZE BUTTON
- 20) **CD2** – CD TRAY OPEN/CLOSE  BUTTON
- 21) **CD2** – CD PLAY/PAUSE  BUTTON
- 22) **CD2** – CD STOP  BUTTON
- 23) 3.5MM HEADPHONE JACK
- 24) 3.5MM AUX-IN JACK
- 25) **CD2** – CD TRAY
- 26) **CD2** – EJECT HOLE
- 27) **CD2** – CD SKIP UP / DOWN  BUTTON
- 28) RECORD  BUTTON
- 29) ERASE BUTTON
- 30) TAPE FAST FORWARD / EJECT BUTTON
- 31) CASSETTE DOOR COVER
- 32) 45 RPM RECORD ADAPTOR
- 33) 33/45/78 RPM SPEED SELECTOR
- 34) TURNTABLE AUTO STOP SWITCH
- 35) TONE ARM HOLDER
- 36) FM WIRE ANTENNA
- 37) L/R SPEAKER WIRE TERMINALS
- 38) RCA LINE OUT JACKS
- 39) AC POWER CORD

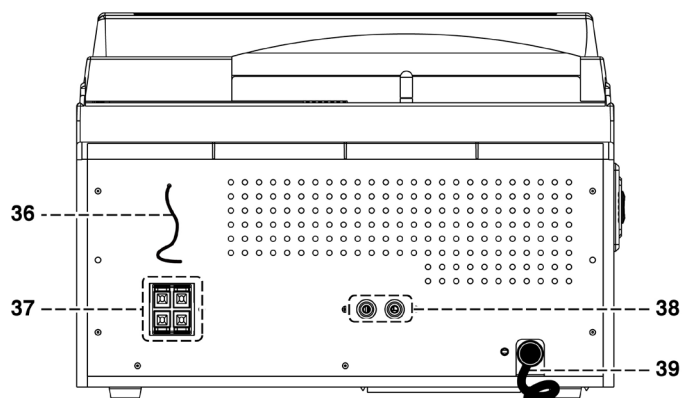
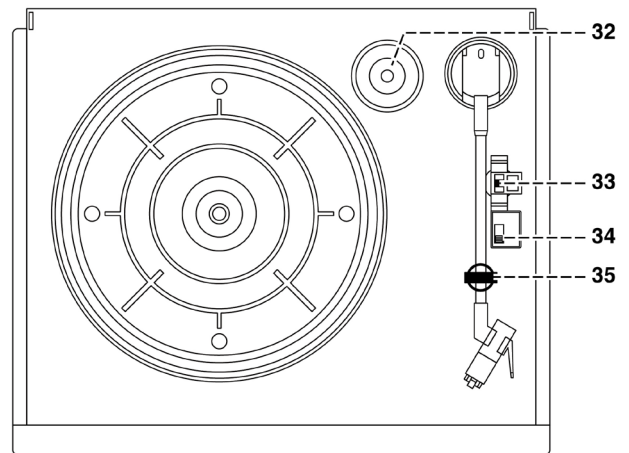
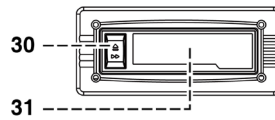
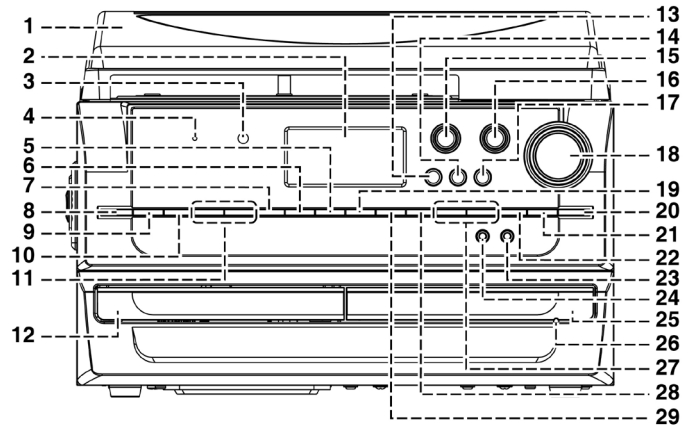

### CAUTION:

This unit should not be adjusted or repaired by anyone except qualified service personnel.

## REMOTE CONTROL

### BUTTON DESCRIPTION

1) POWER /STANDBY BUTTON PRESS TO TURN UNIT POWER ON OR STANDBY

2) FUNCTION BUTTON PRESS TO SELECT RADIO/ CD 2/CD 1/PHONOGRAPH/ TAPE/AUX OPERATION MODE

### EXCLUSIVE FUNCTION FOR CD-2 (3 - 10)

3) PLAY/PAUSE  BUTTON IN CD PLAYER MODE, PRESS TO START /PAUSE CD PLAYBACK. IN CD RECORDING MODE, PRESS TO CONFIRM FUNCTION

4) CD PROGRAM BUTTON PRESS TO ACTIVATE CD PROGRAMMING FUNCTION

5) SKIP UP /DOWN  PRESS TO SELECT PREVIOUS / NEXT TRACKS IN CD MODE

6) STOP  BUTTON PRESS TO STOP CD PLAYBACK

7) RANDOM BUTTON PRESS TO ACTIVATE CD SHUFFLE PLAY FUNCTION

8) REPEAT BUTTON PRESS TO ACTIVATE CD REPEAT 1/ALL

9) REC LEVEL- BUTTON PRESS TO DECREASE CD-R/RW RECORDING LEVEL

10) REC LEVEL+ BUTTON PRESS TO INCREASE CD-R/RW RECORDING LEVEL

11) EQ BUTTON PRESS TO SELECT PRESET EQ

12) VOLUME+/- BUTTON PRESS TO ADJUST THE VOLUME LEVEL UP (+) AND DOWN (-)

### 13) EXCLUSIVE FUNCTION FOR CD-2 (13)

- FINALIZE BUTTON PRESS TO FINALIZE THE CD-R(W) DISC AFTER RECORDING
- ERASE BUTTON PRESS TO ERASE OR UN-FINALIZE A CD-RW DISC
- CD REC  BUTTON PRESS TO ACTIVE CD RECORDING FUNCTION AT CD 2
- CLEAR BUTTON PRESS TO CLEAR THE LATEST PROGRAMMED TRACK
- DISPLAY BUTTON PRESS TO DISPLAY THE TRACK PLAYED / REMAINING TIME
- TRACK SEPARATION IN CD RECORDING MODE, PRESS TO SEPARATE TRACKS BY STARTING A NEW TRACK

### 14) FUNCTION CONTROL FOR , RADIO AND CLOCK (14)

- PLAY MODE BUTTON PRESS TO SELECT REPEAT 1/ALL OR RANDOM PLAY
- MEM/CLK-ADJ BUTTON IN STANDBY MODE, PRESS TO ENTER CLOCK SETUP  
IN RADIO MODE, PRESS TO MEMORY RADIO PRESET  
IN CD 1 MODE, PRESS TO PROGRAM TRACKS
- SLEEP/WAKE UP TIMER IN POWER ON MODE, PRESS TO SELECT SLEEP TIME  
IN STANDBY MODE, PRESS TO ENTER WAKE TO RADIO OR CD 1  
TIMER SETUP

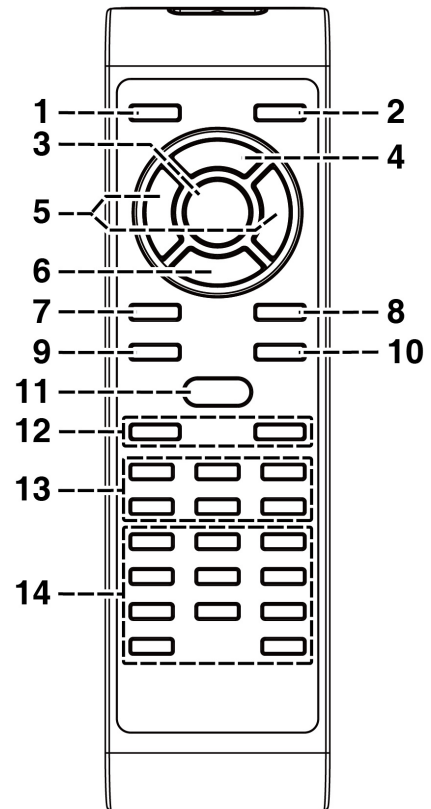

- PLAY/PAUSE ►|| BUTTON    IN CD MODE, PRESS TO START/PAUSE CD PLAYBACK.  
IN RADIO MODE, PRESS TO SELECT AM/FM BAND
- SKIP UP ►►/DOWN ◄◄    IN CD MODE, PRESS TO SELECT PREVIOUS / NEXT TRACKS  
IN RADIO MODE, PRESS TO TUNE FREQUENCY UP/DOWN
- STOP ■ BUTTON    IN CD MODE, PRESS TO STOP PLAYBACK OR PRESS IT TWICE TO  
CANCEL THE STORED PROGRAM  
IN FM RADIO MODE, PRESS TO SELECT FM STEREO/MOMO
- CHANNEL- BUTTON    PRESS TO RECALL RADIO PRESET CHANNEL DOWNWARD
- CHANNEL+ BUTTON    PRESS TO RECALL RADIO PRESET CHANNEL UPWARD
- TIME BUTTON    PRESS TO CHECK CURRENT TIME
- SNOOZE BUTTON    PRESS TO ACTIVATE SNOOZE FUNCTION OF WAKE UP TIMER

## **BATTERY INSTALLATION**

The battery compartment is located on the back of the remote control.

1. Remove the battery compartment door by pressing in on the tab and lifting it off.
2. Insert two (2) AAA size batteries (included) into the battery compartment following the polarity markings inside the battery compartment.
3. Replace the battery compartment door.

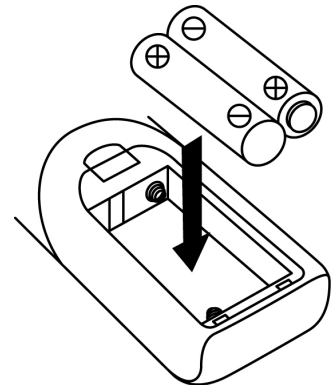

### **Battery Precautions**

- Replacement of batteries must be done by an adult.
- Do not mix old and new batteries.
- Do not mix alkaline, standard (carbon-zinc) or rechargeable (nickel-cadmium) batteries.
- The supply terminals are not to be short-circuited.
- Non-rechargeable batteries are not to be recharged.
- Exhausted batteries are to be removed.
- Only batteries of the equivalent type are to be used.
- Batteries are to be inserted with the correct polarity.
- Dispose of batteries properly. Do not dispose of batteries in fire. The batteries may explode or leak.

# OPERATING INSTRUCTIONS

## SETTING THE CLOCK

---

After plugging in the AC power, “- :- -” will appear and start blinking on the LCD display.

1. In unit standby mode, STANDBY indicator lights. Press and hold the “MEM/CLK-ADJ” button, the 12 hour format 12 H will show on display and digit “12” will keep blinking.
2. Tap the “◀/TUNE” or “TUNE/▶” button to select 24 Hour format if necessary. Otherwise, press the MEM/CLK-ADJ button to confirm 12 Hour clock format and enter clock setup mode, Hour digits will be flashing
3. Tap the “◀/TUNE” or “TUNE/▶” button to adjust the hour. Press and hold the button for fast advance / reverse setting.  
**Note:** Make sure the hour is set so that the **PM** indicator is displayed correctly.
4. Tap “MEM/CLK-ADJ” button to confirm the hour setting, the minute digits will flash to prompt for input.
5. Tap the “◀/TUNE” or “TUNE/▶” button to adjust the minute. Press and hold the button for fast advance / reverse setting.
6. Tap “MEM/CLK-ADJ” button to complete the setting.

**NOTE:** The clock will need to be reset if the power is interrupted or in the event of a power outage. “- :- -” will appear and start blinking on the LCD display to notify you that the power was interrupted and the clock will need to be reset. Please follow steps 1-6 above to reset the clock.

## CHECKING THE CLOCK (REMOTE CONTROL ONLY)

The unit will show current time in standby mode. To check the current time in Power ON mode, press the “TIME” button on remote control, the current time will show for 10 seconds and then return to the previous screen. Press the button again will return to the previous screen immediately.

## LISTENING TO RADIO

---

1. Tap the “POWER /STANDBY” button on main unit or remote control to turn on the unit.
2. Tap the “FUNCTION” button to select “TUNER (Radio)” mode, display shows “TUNE” for a second and then the AM or FM radio frequency will appear on display. Tap the “BAND” button to select AM or FM band.
3. To manually tune to a specific radio station, tap the “◀/TUNE” or “TUNE/▶” button on either the main unit or the remote control repeatedly. Use the manual tuning method to tune in weaker stations that are bypassed during Automatic Tuning.
4. To automatically tune to the next available radio station, press and hold the “◀/TUNE” or “TUNE/▶” button for 1-2 seconds until frequency readout on the display begins to scan and then release the button. The tuner will stop scanning when it receives the next broadcasting station of adequate signal strength.
5. Rotary the VOLUME control knob on main unit or press the “VOL+/-” button on the remote control to adjust the volume to the desired volume level.

## FM & FM-STEREO RECEPTION

- Tap the “BAND” button to select FM radio. When listening to the FM radio, press the “ST./MONO” button to switch between stereo mode and mono mode. The FM stereo icon “” will appear on the display if unit is in stereo mode.
- It is preferable to receive the program in mono when you are receiving a weak FM station.

### Hints for Best Reception:

**AM** - The AM antenna is located inside the cabinet of the unit. If AM reception is weak, change the position of unit until the internal antenna picks up the strongest signal.

**FM** - For best FM reception, the FM lead wire antenna located on the back of the set should be fully unwrapped and extended.

**NOTE:** Automatic tuning depends on the signal strength of the broadcasting station, so weak stations may be skipped. You can manually tune to find the weak stations if a station gets skipped. With strong signals, the tuner may stop before it reaches the actual broadcast frequency, so you may need to manually tune for the best reception.

### **PRESET RADIO STATIONS**

You can store up to 30 FM + 20 AM radio stations in the memory.

1. Press the "POWER 
2. Tap the "FUNCTION" button to select "TUNER (Radio)" mode.
3. Tap the "BAND" button to select AM or FM band.
4. Turn to the desired radio station by "manually" or "automatically" tuning method.
5. Tap the "MEM/CLK-ADJ" button to enable program state and "MEM" indicator is appear and the next available preset memory number flash on LCD display. (Note:"P01" will blink in the display if you are programming preset for first time).
6. Tap the "CHANNEL+" or "CHANNEL-" button on remote control or "CHANNEL+" button on main unit repeatedly to select the desired station memory for storage.
7. Tap the "MEM/CLK-ADJ" button again to confirm the setting.
8. Repeat step 4 to 7 to preset other stations.

### **RECALLING PRESET MEMORY CHANNELS**

In AM or FM radio mode, recall the pre-set channels by pressing the "CHANNEL+" or "CHANNEL-" button on remote control or "CHANNEL+" button on main unit repeatedly.

#### **Notes:**

- All of the pre-set memories will be deleted if the main power supply is disconnected. It's recommended that you switch the system into standby mode for convenience usage.
- There are 5 seconds for program state, after 5 sec. This state would resume to normal tuner mode automatically.
- You can overwrite a present station by storing another frequency in its place.

### **PLAYING COMPACT DISC**

---

**NOTE:** This player will not only play commercial CDs, but also self-complied CD-R/RW discs. Do not attempt to play CD-ROM, CDI, VCD, DVD or computer CDs.

#### **PLEASE READ THIS IMPORTANT INFORMATION:**

CD mechanisms used in devices like this are designed to fully read all commercial CDs. They will also read self-compiled CD-R/CD-RW discs but it may take up to 10 seconds for playback to start. If playback does not start, it is likely due to the quality of the CD-R/RW disc and/or the compatibility of the CD compilation software. Manufacturer is not responsible for the playback quality of CD-R/RW discs.

Do not attach a label or seal to either side of the CD-R/RW disc. It may cause a malfunction.

### **CD PLAYBACK GUIDELINE**

**The CD burner is mainly designed for recording purposes. After recording, the recorded disc may be played back in CD 2, but it is only for checking your recording before finalizing. Please note that the first few seconds of the recording may not play in the CD 2 tray. We recommend only using the CD 1 tray (CD-1 mode) for normal CD playback.**



The following procedure can be accomplished by using the remote and main controls on the unit.

## **PLAYING COMPACT DISC AT**

---

The system is equipped with 2 CD players, below are the functions for .



### ● **GETTING STARTED**

1. Press the "POWER /STANDBY" button to turn on the unit.
2. Tap the "FUNCTION" button repeatedly to select "CD-1" mode, no disk message "NO" will appear on display.  
**Note:** The display will show a "busy" message for few seconds when you change the mode pass through CD-2 mode. Wait until the "busy" message disappears from display and the CD-1 mode shows on display.
3. Press the "Open/Close " button on the unit front panel to open the CD tray.
4. Place a CD with the printed side facing up inside the tray and then press the  button to close the CD tray.
5. After the CD is read, the LCD display shows the total number of tracks for a second and then start to play track 1 automatically. The LCD display will show the current track number and elapsed time alternatively. If a CD is not recognized by the player or if no disc is loaded, the display will show "NO".

### **NOTES:**

- Keep the CD disc tray closed when the system is not in use to prevent dirt and dust from entering the CD mechanism.
- Never place more than one CD in the CD tray. If two discs are loaded at the same time, the CD mechanism may jam and / or the discs themselves may be damaged.
- Never push on the CD door to close it. Always press the "OPEN/CLOSE " button on the unit front panel to open and close the CD tray





### ● **PLAY / PAUSE MODE**

1. If "PLAY/PAUSE " button is pressed during stop mode, the first track will be played .
2. If "PLAY/PAUSE " button is pressed during playback, system go to pause mode and the play indicator "  " will start flashing at the LCD display. Press the button again to resume normal playback.
3. Adjust the volume to the desired level.

### ● **STOP MODE**

If "Stop " button is pressed during play or pause mode, the system will enter stop mode and display the total number of tracks on the LCD display.

### ● **SKIP MODE (SKIP UP /SKIP DOWN**

1. During play or pause mode, if "TUNE/" button is tapped it will go to next track and display the track number and remain in either the PLAY or PAUSE mode.
2. During play or pause mode, if "/TUNE" button is tapped, it will go back to the beginning of the track, the same track number is display and remain in the PLAY or PAUSE mode.
3. After step 2, tap the "/TUNE" button again, it will go to the previous track and remain in the PLAY or PAUSE mode.
4. During play mode, press and hold the "TUNE/" or "/TUNE" button to search within the current track with audible high speed playback.



● **CD PLAY MODE**

Press the “PLAY MODE” button before or during playback, a single track or all the tracks or shuffle track can be played in difference mode as follow:

(1) REPEAT 1 TRACK → (2) REPEAT ALL TRACKS → (3) RANDOM → OFF MODE



PLAY MODE	INDICATOR ON LCD DISPLAY
REPEAT 1 TRACK	C
REPEAT ALL	↻
RANDOM	RAN
OFF MODE	-----

**CD DISC PROGRAMMING**

Up to 20 tacks can be programmed from a CD and play in any order:

1. Switch to “CD-1“ mode and press the “STOP ■” button to stop the CD playback.
2. Press the “MEM/CLK-ADJ” button, “MEM“ indicator will appear and “P01” flashing on LCD display.
3. Select a desired track by tapping the “TUNE/▶▶” or “◀◀/TUNE” button.
4. Press the “MEM/CLK-ADJ” button again to store the track. Program counter advanced to “P02” and flashing.
5. Repeat steps 3 and 4 to enter additional tracks into the memory if necessary.
6. When all the desired tracks are stored, press the “PLAY/PAUSE ▶||” button to play the disc in the assigned order.
7. To cancel the programmed selections, press the “STOP ■” button to stop the CD playback and then press the “STOP ■” button again until the “MEM “indicator disappears from LCD display.

**Important Notices:**

- Always press the “STOP ■” button to stop CD playback and return the LCD to the original information before pressing the “OPEN/CLOSE ▲” button for disc changing.
- Before opening the tray for either **CD1** or **CD-2**, make sure the system is in the CD “STOP” mode and you have deleted all programmed tracks.
- You must close the CD tray(s) (either **CD1** or **CD-2**) before switching to other function mode while operating.

**PLAYING COMPACT DISCS IN CD-2**

Tap the “FUNCTION” button to select **CD-2** mode, wait for the display to show the “CD-2” message. The basic operation of **CD-2** is same as **CD1** except for the following differences:

**Note:** The display will show a “busy” message in CD 2 mode for few seconds. Wait until the “busy” message disappears from display. If there is a CD inside CD tray of CD 2, wait time for the “busy” message to go away could be as long as 15 seconds or longer.

● **When No Disc is Loaded**

- “No disc” message will be shown on display.

● **Play/Pause Mode ▶||**

- After a CD is read, the LCD display will show the total number of tracks and time. Press the “PLAY/PAUSE ▶||” button to start playback first track of the CD.
- To temporarily stop playback, press the “PLAY/PAUSE ▶||” button once, the playing time will be stop on the LCD display. Press the “PLAY/PAUSE ▶||” button once more to cancel pause and resume playback.

● **Skip Mode (Skip Up ►►/Skip Down ◀◀)**

- The system will go to the next or previous track only when you tap the Skip button during PLAY or PAUSE mode.

**Notes:**

- Before pressing the “ CD2 Open/Close ▲” button when changing discs, press the CD 2 “STOP ■” button every time and resume the CD Recorder operation display area to the original information.
- Never push on the CD door to close it. Always press the ”OPEN/CLOSE ▲” button on the unit front panel to open and close the CD tray
- The CD burner reaction time is longer than a normal CD player. If you keep pressing buttons while the CD burner is operating, you might cause a malfunction of the system. Please re-start the unit if this is happen.
- The reading and playback time of some CD-R/RW discs vary from brand to brand. It depends on the compatibility of the used disc.
- This device only design for normal compact disc format. Is not support any MP3/WMA format.

● **Random Play Mode (Remote Control Only)**

- Press the “RANDOM” button on remote control to activate the shuffle play function and the random indicator “RAN“ will show on the LCD display. Press the “RANDOM” button again to cancel the random play function.

● **Repeat Play Mode (Remote Control Only)**

Press the “REPEAT” button on remote control before or during playback, a single track or all the tracks can be played in difference mode as follow:-



Play mode	Indicator on CD Recorder
Repeat all	↻
Repeat 1	↻1
Off mode	-----

● **CD Disc Programming (Remote Control Only)**

Up to 32 tracks can be programmed when using CD-2.

1. Turn on the unit and tap the “FUNCTION” button to select CD-2 mode. Wait until “busy” message disappeared from display and stop the disc playback.
2. Press the “PROGRAM” button on the remote control, “ PROG “ indicator will appear. Moreover, it will indicate program number (P-01) and digits for track number to be programmed on LCD display.
3. Select a desired track by tapping the “SKIP UP ►►” or “DOWN ◀◀” button of CD 2.
4. Press the “PROGRAM” button to store the track into memory.
5. Repeat steps 3 and 4 to enter additional tracks into the memory if necessary.
6. When all the desired tracks have been programmed, press CD 2 “PLAY/PAUSE ►||” button to play the disc in assigned order.
7. To cancel the programmed track, pressing CD 2 “STOP ■” button twice in CD 2 stop mode until “ PROG “ indicator is disappear on LCD display.

**Notes:**

- After a programmed played, you can delete the programmed tracks in the order from the last one to the first one by pressing the “CLEAR” button on the remote control. Press “STOP ■” button then press the “CLEAR” button once by once to clear the program from last programmed track. This function allows you to re-program the memory half way through if necessary.
- Repeat play is not function in CD 2 program mode.



- **Display Information (Remote Control Only)**

- During CD playback, press the “DISPLAY” button on remote control to toggle between elapsed time or time remaining for the track being played.

## **RECORDING FUNCTION ON CD-2**

---

Apart from the CD playback function, **CD-2** can perform the CD recording function either from CD 1, PHONOGRAPH, TAPE or AUX modes. All recorded tracks will be stored in “**AUDIO-CD**” format.

Before starting, place a blank CD-R or CD-RW disc onto the **CD-2** tray. The disc will be able to be recorded on if the LCD display shows the “NO TOC” indicator.

**NOTE:** A CD-R disc can only be recorded once and does not support erase or re-record function. The playback quality of CD-R/RW discs vary depending on the type of audio CD player they are used in.

### **Important Notices:**

- The speed that the CD spins at in **CD-2** (CD Burner) is much higher than a normal CD mechanism. Some mechanical noise and cabinet vibration may occur during operation. This is normal and not a malfunction of the system.
- Quality and compatibility of CD-R/RW discs on the market varies. Please change to another brand if you are having problems burning a specific type or brand of disc.

## **A) RECORDING MODE**

### **I) CD RECORDING**

#### **i) Manual Recording**

- 1) Tap the “FUNCTION” button to enter **CD1** mode. Place a source CD inside the **CD1** tray. After the CD is read, press the “STOP ■” button on CD 1 to stop the CD playback.
- 2) Load a recordable CD-R/RW disc into **CD-2** tray. Press the “REC ●” button and then the CD “PLAY/PAUSE ►II” button on **CD-2** until the recording indicator “►” shows on LCD display.
- 3) After few seconds, the LCD will show the time counter notifying you that the system is recording. Now start the playback of the CD in **CD1** tray.
- 4) During the recording process, you can record a desired session by pressing the “TRACK SEPARATION” button. A new CD track will be created and continue recording the next session (track).
- 5) When the recording is completed, press the “STOP ■” button on **CD-2** and then stop the playback of **CD1**.

#### **ii) Recoding by Program**

- 1) Tap the “FUNCTION” button to enter **CD1** mode. Place a source CD inside **CD1** tray in STOP mode.
- 2) Select the desire tracks by following the “**CD Disc Programming**” procedures.
- 3) Repeat the same procedures from step 2 to 5 as described on part A-I-i from above (manual recording) to complete the recording process.

### **II) PHONOGRAPH RECORDING**

- 1) Tap the “FUNCTION” button to enter “PHONO (phonograph)” mode. Place the record on the turntable and get ready for playback.
- 2) Press the “REC ●” button and then the CD “PLAY/PAUSE ►II” button on **CD-2** until the recording indicator “►” shows on LCD display.
- 3) After few seconds, the LCD will show the time counter and the system is now recording. Now start the playback of the record in PHONO mode.
- 4) During the recording process, you can record a desired session by pressing the “TRACK SEPARATION” button. A new CD track will be created and continue recording the next session (track).

- 5) After completion of recording, press the “STOP ■” button at **CD-2** and then stop the playback of the record.

### **III) CASSETTE RECORDING**

- 1) Tap the “FUNCTION” button to enter “TAPE” mode. Get the tape ready for playback.
- 2) Press “REC ●” button and then the CD “PLAY/PAUSE ►||” button at **CD-2** until the recording indicator “►” shows on LCD display.
- 3) After few seconds, the LCD will show the time counter and now the system is start recording process. Insert the cassette tape to start playback.
- 4) During the recording, you can record the desired session by pressing the “TRACK SEPARATION” button. A new CD track will be created and continue recording the next session (track).
- 5) After completion of recording, press the “STOP ■” button at **CD-2** and then stop the playback of the cassette tape.

### **IV) AUX-IN RECORDING**

- 1) Tap the “FUNCTION” button to enter “AUX” mode. Connect the headphone output at the audio device (such as MP3 player and CD player) to the 3.5mm AUX-IN jack via a 3.5 mm connecting cable (not provided).
- 2) Repeat the same procedures from step 2 to 5 as described on other recording modes from above.
- 3) Adjust the volume output level at your audio player device if the recording level is too high.

### **NOTES:**

- This unit supports 1X recording speed which is in synchronization with the actual playing time of the source.
- When you press the “PLAY/PAUSE ►||” button on **CD-2** during the recording, a “busy” message will briefly appear on the LCD display and the recording is paused. To start recording a new track, press the “PLAY/PAUSE ►||” button again, the recording indicator “►” will show on the LCD display.
- To enable recording in different modes, you must press the **CD-2** “STOP ■” button to exit before you switch from one mode to another mode.
- When the capacity of CD-R/RW is full, the display will appear “FULL” message, press **CD-2** “STOP ■” button and change another empty CD-R/RW disc for continue recording.

## **B) RECORDING SETTINGS**

### **I) RECORDING LEVEL (REMOTE CONTROL ONLY)**

The preset recording level of the system is lower than original music source in order to avoid distortion during recording except AUX-IN recording mode. If you record a CD via AUX IN mode, you are recommend to try a short recording to determine that no distortion will occur after adjust your external MP3 or CD player volume level.

### **II) MANUAL TRACK SEPARATION**

You can divide the recording into separate tracks at anytime. When you press the “TRACK SEPARATE” button once while recording in any mode, the system will generate a new track and then continue the recording of the new track in few seconds. A “busy” message will briefly show on LCD display, it means the unit is creating a new track.

### **III) FINALIZE A CD-R/RW DISC**

You must convert the CD-R/RW disc into standard CD before playing at other audio CD player. This process is knows as finalizing and a table of contents (TOC) will be written to the CD at the same time:

1. Tap the “FUNCTION” button to enter the **CD-2** mode and place the CD-R/RW disc you are going to finalize in **CD-2** compartment.
2. Press the “FINALIZE” button during CD stop mode, “FIN-d” message will appear on the LCD display. Press the “STOP ■” button to quit finalize mode if necessary.

3. Press the “PLAY/PAUSE ►II” button to start finalizing and the LCD will show “busy “ during the process.
4. After completion, the CD tray will open automatically and the “NO TOC” indicator will disappear from LCD display when you load the disc that has been finalized.

**Notes:**

- The time for finalizing is subject to the contents of the recording and it may take up to 15 minutes in some cases.
- During finalize processing, do not change the function mode, please wait until finalize completed.
- Never turn off the power or un-plug the power cord during finalize process.
- The CD-R disc cannot be recorded again after finalizing.
- Finalized CD-R discs can be played in ordinary CD players, but finalized CD-RW disc may not play in ordinary CD players.
- Due to the variance of the compatibility of CD-R or CD-RW discs in the market, please change to other one if you find the recording performance of the existing one unacceptable. This is not a malfunction of the system.

**C) UN-FINALIZE OR ERASE A CD-RW DISC**

It is possible to erase the last recorded track or erase a whole record disc (CD-RW only).

**I) UN-FINALIZE A CD-RW DISC**

1. Tap the “FUNCTION” button to enter the **CD-2** mode and place the CD-RW disc to be un-finalized in **CD-2** compartment.
2. Wait until “busy” disappears from the LCD display, total track and time of CD-RW will show. Tap the “ERASE“ button with the CD in stop mode, the message “UN FIN-d“ will appear on the LCD display.
3. Press the “PLAY/PAUSE ►II” button to start the un-finalize process and wait until “busy” message disappears from the LCD display.
4. “NO TOC “ indicator, total track numbers and playing time will appear on the LCD display after the un-finalize process is completed.

**II) ERASE ONE TRACK**

1. Tap the “FUNCTION” button to enter the **CD-2** mode and place the CD-RW disc to be erased in **CD-2** compartment. Wait until the “busy” message disappears from the LCD display. If the disc is finalized, you have to un-finalize it before you can delete tracks.
2. Tap the “ERASE“ button when CD-RW in stop mode, erase the last track message “Er XX(track no.)” will appear on the LCD display.
3. Press the “PLAY/PAUSE►II” button to start erasing the last track.
4. Repeat step 2 and 3 to continue the erasing.
5. Press the “STOP ■” button to quit the erase mode if necessary.

**III) ERASE ALL TRACKS**

1. Tap the “FUNCTION” button to enter the **CD-2** mode and place the CD-RW disc to be erased in **CD-2** compartment.
2. Press the “ERASE“ button twice with the CD in stop mode and wait until erase all message “Er ALL“ appears on the LCD display.
3. Press the “PLAY/PAUSE►II” button to start erasing.
4. The LCD will show “0000000“ to confirm the erase process is completed.

**Notes:**

- This operation cannot be undo.
- You cannot erase tracks one-by-one on a CD-RW disc recorded on another system, but it is possible to erase all.
- During un-finalize or erase in processing, do not change the function mode, please wait until un-finalize or erase completed.

## LISTENING TO TAPE

### GENERAL OPERATION

1. Tap the "FUNCTION" button to enter the "TAPE" mode.
2. The system will start playback automatically after inserting the cassette tape.
3. Adjust the volume to the desired level.
4. Press the TAPE FAST FORWARD / EJECT button half way when playing, the tape will be advanced forward rapidly.
5. Slightly press the TAPE FAST FORWARD / EJECT button again to resume normal playback. The button will resume to the outermost position.

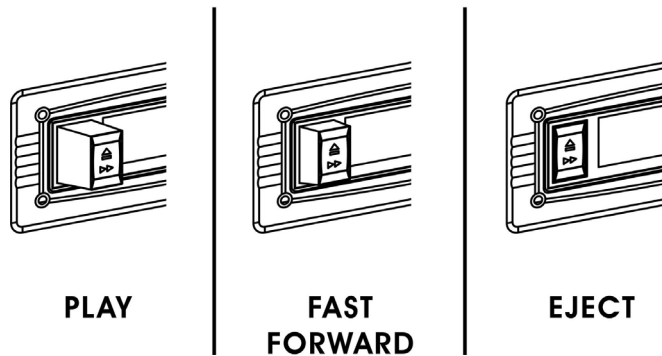
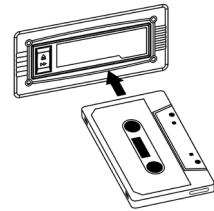

6. Press the TAPE FAST FORWARD / EJECT button completely, then the playing will be stopped and the cassette tape will be ejected.

#### Notes:

- Make sure the direction is correct when inserting the tape.
- Some searching noise can be heard and the system cannot perform normal playback function during fast forward mode.
- To avoid damaging the tape, it is recommended to take the cassette tape out of the deck after listening.

## STEREO PHONOGRAPH OPERATION

### Note, Before Use:

- Lift up the turntable dust cover until it can hold position.
- Move up the stylus protector.
- Be sure that the tone arm is detached from the tone arm rest before operating, and replace again when finished.

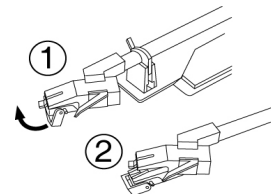

1. Tap the "FUNCTION" button to enter the "PHONO" mode. Display will show "PHON".
2. Place the record on the platter, over the center spindle (use the 45 RPM record adaptor when playing 45 RPM record).
3. Set the Speed selector to 33, 45 or 78 RPM according to the record you are playing.
4. Lift the tone arm from the rest and slowly move it over the record. The platter will turn.
5. Move the tone arm to the beginning of the record, or to the start of a particular track. Gently lower the tone arm onto the record to start playing.
6. Adjust the volume to the desired level.
7. When the record is played to the end of the record, the platter will automatically stop rotating. Lift the tone arm and return it to the rest position.
8. To stop the record manually when playing, lift up the tone arm and return it to the rest position.

#### Note:

Some types of records may have an auto-stop area outside the preset limit, so the turntable may stop before the last track finishes. In this case, set the auto-stop switch to the "OFF" position. This allows the record to play to the end, but it will not stop automatically. You must manually raise the tone arm and place it back in the rest to stop the turntable from spinning and turn it off.

## PRESET EQ

---

This unit provides 5 different EQ modes to enhance your listening experience. You can select the desired effect by pressing the “EQ” button on remote control repeatedly at following sequence:

FLA (FLAT) → CLA (CLASSIC) → ROC (ROCK) → POP → JAZ (JAZZ)

## LINE OUT CONNECTION

---

You can connect this unit to an external Hi-Fi / AMPLIFIER system by connecting the LINE OUT socket to the auxiliary input socket of your Hi-Fi / AMPLIFIER system with RCA cables (not included).

**Note:** The Volume control on the main unit will not adjust the volume when using the LINE OUT.

## 3.5MM STEREO HEADPHONE JACK

---

The stereo headphone jack is located on the right front panel. Plug a set of stereo headphones (not included) into this jack for private listening without disturbing others. The speakers are automatically disconnected when headphones are connected to the jack.

### Read this Important Information before Using Your Headphones

- 1.) Avoid extended play at very high volume as it may impair your hearing.
- 2.) If you experience ringing in your ears, reduce the volume or shut off the unit.
- 3.) Keep the volume at a reasonable level even if your headset is an open-air type designed to allow you to hear outside sounds. Please note that excessively high volume may still block outside sounds.

## EXTRA FEATURES

---

### A. SLEEP SETTING

The sleep function enables the system to automatically switch to standby mode at a pre-set time.

1. In unit power on mode, tap the “SLEEP/W.TIMER” button and sleep indicator “zzz” shown on the LCD display.
2. Repeatedly tap the button to select the sleep time in the order of SLEEP 90 > 80 > 70 > 60 > 50 > 40 > 30 > 20 > 10 minutes.
3. The unit will stop and go into standby mode automatically after the selected time expires.
4. To cancel the sleep mode, repeatedly tap the “SLEEP” button until the sleep time and the “zzz” indicator disappear from LCD display.

### B. WAKE UP TIMER SETTING

This function allows the system to turn on automatically, and wake you to CD1 or TUNER (Radio).

1. In unit standby mode, press and hold the “SLEEP/W.TIMER” button to enter the setting mode, wake up time “12:00” will appear, Hour digits and “⌚” icon will flashing in the LCD display.
2. Tap the “◀◀/TUNE” or “TUNE/▶▶” button to set the hour and then tap the “W.Timer” button again to confirm the hour. The minutes digits will flashing.  
**Note:** Make sure the hour is set so that the **PM** indicator is displayed correctly
3. Tap the “◀◀/TUNE” or “TUNE/▶▶” button to set the minute and then tap the “W.Timer” button to store the timer on time. Wake up source “TUNE” or “CD-1” will flash.
4. Tap the “◀◀/TUNE” or “TUNE/▶▶” button to set the to select the wake up timer source and then tap the “W.Timer” button to finish wake up timer setup.

### Notes:

- The wake up volume is preset at level 21. It will sound for one hour if no snooze button is pressed.
- Press any control button (except CD 2) during wake up timer sounding will stop wake up timer mode immediately, the “⌚” icon will stop flashing. You need to press the “⏻/STANDBY” button to manually turn off the unit.
- If there is no music source being detected (such as CD) when the preset time is reached, system will default to tuner mode automatically.

- For tuner wake up, the system will preset at the latest radio frequency being listened before switching off.

#### **ACTIVE/DE-ACTIVE TIMER FUNCTION**

1. To active wake up timer function, tap the "W.TIMER" button once in standby mode, the timer indicator "⌚" will appear on LCD display.
2. To cancel the timer function, tap the "W.TIMER" button again, the timer indicator "⌚" disappear from display.

#### **SNOOZE FUNCTION (REMOTE CONTROL ONLY)**

Press the "SNOOZE" button once to terminate the wake up timer temporarily, the "⌚" icon keeps flashing and the wake up timer will re-start again after 9 minutes on each press. To cancel the SNOOZE mode, press the "SNOOZE" button again, the wake up timer "⌚" icon will stop flashing.

### **AUXILIARY INPUT**

This unit provides an auxiliary audio signal input jack for connecting external audio devices like MP3 players, CD players and older, non-dockable iPods (except iPod shuffle 3<sup>rd</sup> gen) so you can listen to your external source through the speakers of this system.

1. Use an audio cable (not included) with one 3.5 mm stereo plug on each end of the cable.
2. Plug one end into the AUX-IN jack on the front panel of main unit and the other end of the cable into the Line-out Jack or Headphone Jack of your external audio device.
3. Turn on the external audio device.
4. To select auxiliary audio input, tap the "FUNCTION" button to select "AUX" mode.
5. The volume level can now be controlled through the main unit. Operate all other functions on the auxiliary device as usual.

#### **Note:**

- (1) If the Line Out Jack of your external device is connected, then you only need to adjust the volume control of this system. If the Headphone Jack of your external device is connected, then you may need to adjust both the volume control of your external device and the volume control of this system to find the most desirable volume setting.
- (2) Slide the MODE SWITCH to turn off the system when you finish listening. Don't forget to switch off the power on your external device as well.

### **RESETTING**

If the system does not respond or has erratic operation, you may have experienced an electrostatic discharge (ESD) or a power surge that triggered the internal computer to shut down automatically. If this occurs, disconnect main unit power by unplug the AC POWER cord and wait for three minutes, then plug the AC power cord into AC outlet again. You will need to reset the clock, wake up timer and radio presets.

### **CARE AND MAINTENANCE**

1. Do not subject the unit to excessive force, shock, dust or extreme temperature.
2. Do not tamper the internal components of the unit.
3. Clean your unit with a dry cloth. Solvent or detergent should never be used.
4. Avoid leaving your unit in direct sunlight or in hot, humid or dusty places.
5. Keep your unit away from heating appliances and sources of electrical noise such as fluorescent lamps or motors.



6. Always clean the outside of the cabinet thoroughly if it becomes wet with moisture or water splashes. This will help to protect the internal parts of the unit from entry of water and possible moisture damage.

### CASSETTE CARE

Two common causes of trouble experienced when using cassettes are:

- 1) Tape Jamming – Leading to uneven speed in playback, and
- 2) Tape Tangling – Where the tape wraps itself around ital parts of the mechanism.

To reduce the likelihood of these problems occurring, the following precautions should be observed:

- Check that there are no loose layers of tape visible through the cassette center window (see Fig. 1). Take up any loose layers, using a pencil or hexagonal barrelled ballpoint pen, before inserting the cassette into the machine (see Fig.2).
- If the cassette feels tight while performing operation shown (see Fig.2), the tape may be jamming due to ridges formed in the winding of the tape (visible through the center window). These may be removed, in most cases, by fast winding of the cassette from one end to the other and back again.
- Use only well-known brands of tape. Avoid use of C-120 cassettes.

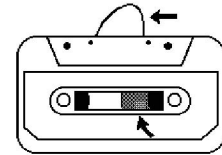

Fig.1

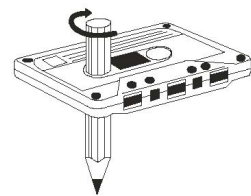
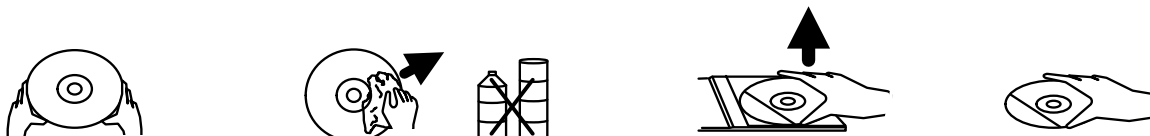

Fig. 2

Furthermore, do not expose cassettes to direct sunlight, dust or oil, and do not touch the tape surfaces.

### COMPACT DISC CARE

- Handle the disc only by its edges. Never allow your fingers to come in contact with the shiny, unprinted side of the disc.
- Do not attach adhesive tape, stickers etc., to the disc label.
- Clean the disc periodically with soft, lint-free, dry cloth. Never use detergents or adhesive cleaners to clean the disc. If necessary, use a CD cleaning kit.
- If disc skips or gets stuck on a section of the disc, it is probably dirty or damaged (scratched).
- When cleaning the disc, wipe in straight lines from the center of the disc to the edge of the disc. Never wipe in circular motions.
- To remove a disc from its storage case, press down on the center of the case and lift the disc out, holding it carefully by the edges.
- Fingerprints and dust should be carefully wiped off the disc's recorded surface with a soft cloth. Unlike conventional records, compact discs have no grooves to collect dust and microscopic debris so gently wiping with a soft cloth should remove most particles.



## MANUALLY EJECT THE CD

If the power is interrupted or if you notice a problem occurs during the CD burning process, the CD tray may not eject when the eject button  is pressed. If this occurs, you will need to manually eject the CD tray to retrieve the CD following the steps below.

1. Turn OFF the power to the unit. Do not manually open the tray when there is power to the drive.
2. Locate the manual eject hole on the front of the CD tray as shown below.
3. Carefully insert a stiff wire, such as a straightened paper clip, into the manual eject hole.
4. When resistance is felt, gently press harder until the drive tray opens slightly.
5. Pull the tray out the rest of the way to expose the CD.
6. Restart the system and repeat the burning process again.

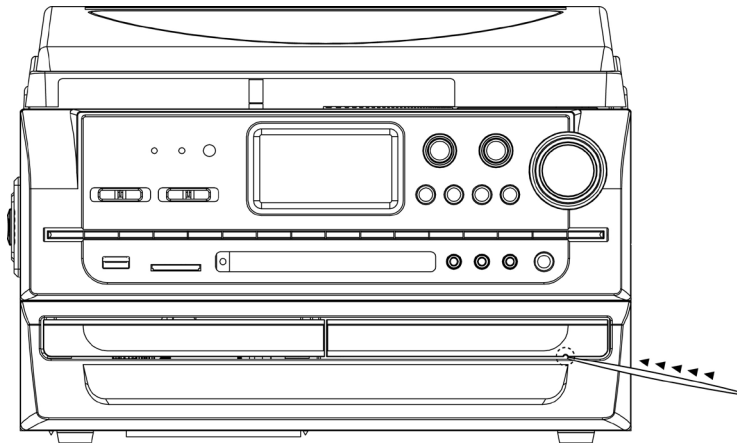

## CLEANING THE UNIT

- To prevent fire or shock hazard, disconnect your unit from the AC power source when cleaning.
- The finish on the unit may be cleaned with a dust cloth and cared for as other furniture, Use caution when cleaning and wiping the plastic parts.
- If the cabinet becomes dusty wipe it with a soft dry dust cloth. Do not use any wax or polish sprays on the cabinet.
- If the front panel becomes dirty or smudged with fingerprints it may be cleaned with a soft cloth slightly dampened with a mild soap and water solution. Never use abrasive cloths or polishes as these will damage the finish of your unit.

**CAUTION:** Never allow any water or other liquids to get inside the unit while cleaning.



## TROUBLESHOOTING GUIDE

SHOULD YOU EXPERIENCE DIFFICULTIES IN THE USE OF THIS PLAYER PLEASE REFER TO THE FOLLOWING CHART OR CALL 1-800-777-5331 FOR CUSTOMER SERVICE.

<b>PROBLEM</b>	<b>POSSIBLE CAUSE</b>	<b>SOLUTION</b>
The unit does not respond (no power)	The unit is disconnected from the AC outlet.	Reconnect to the AC outlet.
	AC outlet is not functioning.	Plug another device into the same outlet to confirm the outlet is working.
AM band is too noisy	The reception at the set location is poor.	Slightly rotate the unit for the best reception.
FM STEREO indicator does not light up	You have tuned to a mono station or the station is too weak.	Select another FM station or extend or rotate the wire antenna for best reception.
	FM MONO MODE is set.	Set the FM MODE to STEREO.
Sound is distorted	Volume level is set to high.	Decrease the volume.
	Sound source is distorted.	Try a different audio source such as a music CD.
The tape does not move.	The cassette tape is not inserted properly. The tape has reached the end.	Insert the cassette tape correctly. Flip the cassette.
No sound from tape.	The tape heads are dirty.	Clean the tape heads.
Tape sound is distorted or faint.	The tape heads are dirty.	Clean the tape heads.
CD Player does not play.	CD Mode is not selected.	Tap the FUNCTION button to select CD mode.
	CD is not installed or installed incorrectly.	Press the CD onto spindle, printed side facing up.
CD skips while playing	Disc is dirty or scratched.	Wipe with cloth or another disc.
Unit gets warm after extended play at high volume	This is normal.	Turn the unit off for a period of time or lower volume.
CD1/CD2 does not work after pushing in the CD tray	The "OPEN/CLOSE" button was not pressed to close the CD.	The "OPEN/CLOSE" button must be pressed to closed the CD tray. Do not push on the CD tray to close it.

## SPECIFICATION

### **Power Requirement**

Main unit:	AC120V~ 60Hz
Remote control	2 x 1.5V "AAA" (UM-4) size batteries

### **Frequency Range**

Radio Band	FM 87.5 ~ 108 MHz AM 520 ~ 1710 KHz
------------	----------------------------------------

### **Power Consumption**

Main Unit:	22 Watts
------------	----------



At Spectra, environmental and social responsibility is a core value of our business. We are dedicated to continuous implementation of responsible initiatives with an aim to conserve and maintain the environment through responsible recycling.

Please visit us at <http://www.spectraintl.com/green.htm> for more information on Spectra's green initiatives or to find a recycler in your area.

**90 DAY LIMITED WARRANTY AND SERVICE  
VALID IN THE U.S.A ONLY**

SPECTRA MERCHANDISING INTERNATIONAL, INC. warrants this unit to be free from defective materials or factory workmanship for a period of 90 days from the date of original customer purchase and provided the product is utilized within the U.S.A. This warranty is not assignable or transferable. Our obligation under this warranty is the repair or replacement of the defective unit or any part thereof, except batteries, when it is returned to the SPECTRA Service Department, accompanied by proof of the date of original consumer purchase, such as a duplicate copy of a sales receipt.

You must pay all shipping charges required to ship the product to SPECTRA for warranty service. If the product is repaired or replaced under warranty, the return charges will be at SPECTRA's expense. There are no other express warranties other than those stated herein.

This warranty is valid only in accordance with the conditions set forth below:

1. The warranty applies to the SPECTRA product only while:
  - a. It remains in the possession of the original purchaser and proof of purchase is demonstrated.
  - b. It has not been subjected to accident, misuse, abuse, improper service, usage outside the descriptions and warnings covered within the user manual or non-SPECTRA approved modifications.
  - c. Claims are made within the warranty period.
2. This warranty does not cover damage or equipment failure caused by electrical wiring not in compliance with electrical codes or SPECTRA user manual specifications, or failure to provide reasonable care and necessary maintenance as outlined in the user manual.
3. Warranty of all SPECTRA products applies to residential use only and is void when products are used in a nonresidential environment or installed outside the United States.

This warranty gives you specific legal rights, and you may also have other rights which vary from state to state. TO OBTAIN SERVICE please remove all batteries (if any) and pack the unit carefully and send it freight prepaid to SPECTRA at the address shown below. IF THE UNIT IS RETURNED WITHIN THE WARRANTY PERIOD shown above, please include a proof of purchase (dated cash register receipt) so that we may establish your eligibility for warranty service and repair of the unit without cost. Also include a note with a description explaining how the unit is defective. A customer service representative may need to contact you regarding the status of your repair, so please include your name, address, phone number and email address to expedite the process.

IF THE UNIT IS OUTSIDE THE WARRANTY PERIOD, please include a check for \$130.00 to cover the cost of repair, handling and return postage. All out of warranty returns must be sent prepaid.

It is recommended that you contact SPECTRA first at 1-800-777-5331 or by email at [custserv@spectraintl.com](mailto:custserv@spectraintl.com) for updated information on the unit requiring service. In some cases the model you have may be discontinued, and SPECTRA reserves the right to offer alternative options for repair or replacement.

SPECTRA MERCHANDISING INTERNATIONAL, INC.  
4230 North Normandy Avenue,  
Chicago, IL60634, USA.  
1-800-777-5331

To register your product, visit the link on the website below to enter your information.  
<http://www.spectraintl.com/wform.htm>

**0815**

Printed in China