



AM/FM ARMBAND RADIO WITH CLOCK AND ALARM



**USER MANUAL
SAB-55A**

**PLEASE READ THIS USER MANUAL COMPLETELY BEFORE OPERATING THIS
UNIT AND RETAIN THIS BOOKLET FOR FUTURE REFERENCE.**

IMPORTANT SAFETY INFORMATION

Read these instructions.

Keep these instructions.

Heed all warnings.

Follow all instructions.

Do not use these apparatus near water.

Clean only with dry cloth.

Do not block any ventilation openings.

Install in accordance with manufacturer's instructions.

Do not install or operate near any heat sources such as radiators, stoves, or other apparatus that produce heat.

No naked flame sources such as candles should be placed on the product.

Caution: Changes or modifications not expressly approved by the manufacturer could void the user's authority to operate this device.

COMPLIANCE WITH FCC REGULATIONS

This device complies with Part 15 of the FCC Rules. Operation is subject to the following two conditions:

- (1) this device may not cause harmful interference, and
- (2) this device must accept any interference received, including interference that may cause undesired operation.

NOTE : This equipment has been tested and found to comply with the limits for a Class B digital device, pursuant to Part 15 of the FCC Rules. These limits are designed to provide reasonable protection against harmful interference in a residential installation. This equipment generates, uses and can radiate radio frequency energy and, if not installed and used in accordance with the instructions, may cause harmful interference to radio communications. However, there is no guarantee that interference will not occur in a particular installation. If this equipment does cause harmful interference to radio or television reception, which can be determined by turning the equipment off and on, the user is encouraged to try to correct the interference by one or more of the following measures:

- Reorient or relocate the receiving antenna.
- Increase the separation between the equipment and receiver.
- Connect the equipment into an outlet on a circuit different from that to which the receiver is connected.
- Consult the dealer or an experienced radio/TV technician for help.

CAUTION: Changes or modifications not expressly approved by the party responsible for compliance could void the user's authority to operate the equipment.

Dear JENSEN Customer

Selecting fine audio equipment such as the unit you've just purchased is only the start of your musical enjoyment. Now it's time to consider how you can maximize the fun and excitement your equipment offers. This manufacturer and the Electronic Industries Association's Consumer Electronics Group want you to get the most out of your equipment by playing it at a safe level. One that lets the sound come through loud and clear without annoying blaring or distortion and, most importantly, without affecting your sensitive hearing. Sound can be deceiving. Over time your hearing "comfort level" adapts to higher volumes of sound. So what sounds "normal" can actually be loud and harmful to your hearing. Guard against this by setting your equipment at a safe level BEFORE your hearing adapts.

To establish a safe level:

- Start your volume control at a low setting.
- Slowly increase the sound until you can hear it comfortably and clearly, and without distortion.
- Once you have established a comfortable sound level. Set the dial and leave it there.

Take a minute to do this now will help to prevent hearing damage or loss in the future. After all, we want you listening for a lifetime.

We Want You Listening For a Lifetime

Used wisely, your new sound equipment will provide a lifetime of fun and enjoyment. Since hearing damage from loud noise is often undetectable until it is too late, this manufacturer and the Electronic Industries Association's Consumer Electronics Group recommend you avoid prolonged exposure to excessive noise.



Customer's Record:

The serial number of this product is found on its bottom. You should note the serial number of this unit in the space provided as a permanent record of your purchase to aid in identification in the event of theft or loss.

Model Number: SAB-55A

Serial Number: _____

LOCATION OF CONTROLS

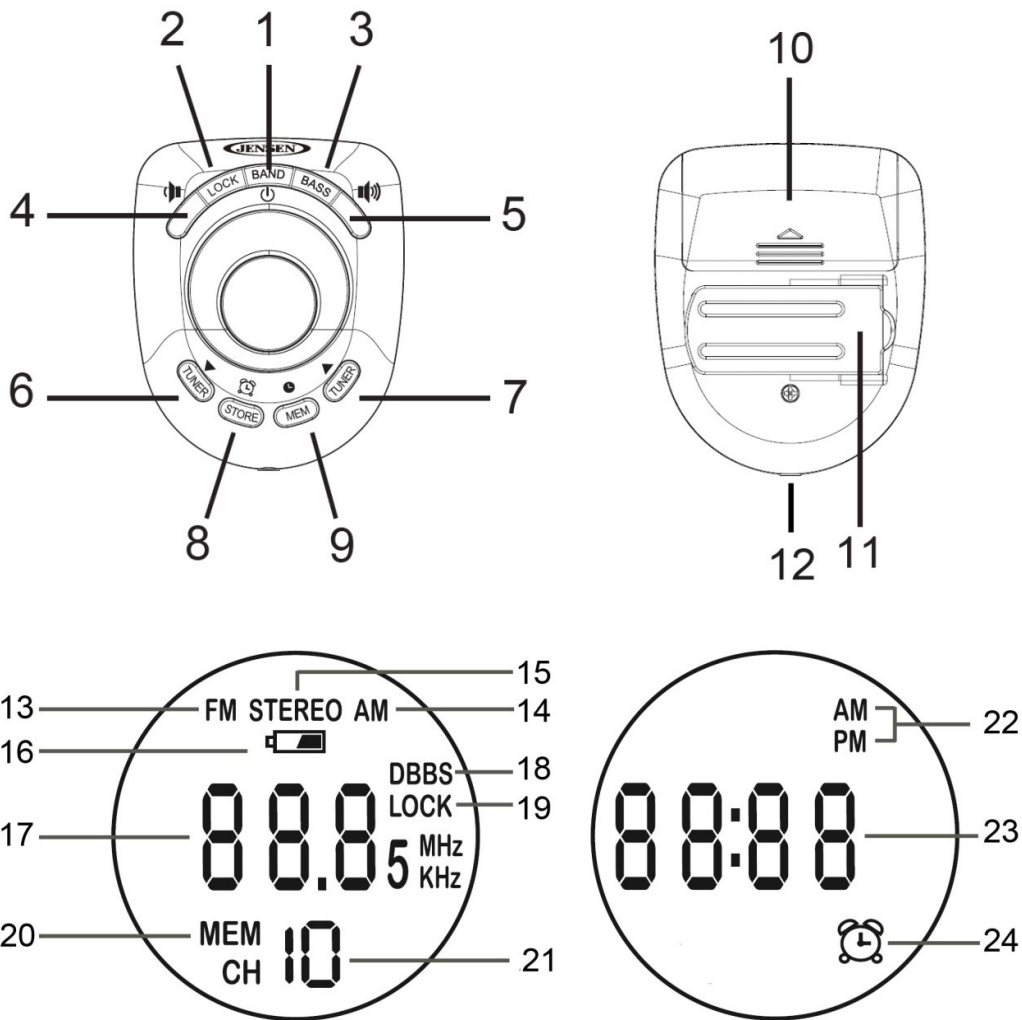

1. POWER / BAND BUTTON
2. LOCK BUTTON
3. BASS BUTTON
4. VOLUME DOWN BUTTON
5. VOLUME UP BUTTON
6. TUNER DOWN BUTTON
7. TUNER UP BUTTON
8. STORE / ALARM BUTTON
9. MEMORY / TIME BUTTON

10. BATTERY COMPARTMENT
11. BELT CLIP
12. EARPHONE JACK
13. FM RADIO INDICATOR
14. AM RADIO INDICATOR
15. FM STEREO INDICATOR
16. LOW BATTERY INDICATOR
17. FREQUENCY READING
18. DBBS INDICATOR
19. LOCK INDICATOR
20. MEMORY INDICATOR
21. PRESET CHANNEL NUMBER
22. AM/PM INDICATOR
23. TIME DISPLAY
24. ALARM CLOCK INDICATOR

GETTING STARTED

POWER SOURCE

This DIGITAL AM/FM STEREO ARMBAND RADIO operates on 2 'AAA' (UM-4) batteries (not included).

INSTALLING BATTERY

1. Remove the BATTERY DOOR.
2. Following the polarity diagram (+ and -) shown in the battery compartment (#10), insert 2 'AAA' (UM-4) batteries (not included).
3. Close the BATTERY DOOR.

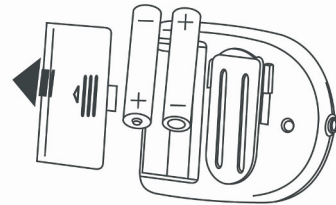

Note:

- Replace the batteries when the LOW BATTERY INDICATOR (#16) show on the LCD display and flash.
- When changing batteries, you will lose the time and your presets.
- For better performance and longer operating time, we recommend the use of alkaline-type batteries

BATTERY WARNING

1. Be sure that the batteries are installed correctly. Wrong polarity may damage the unit.
2. (a) Do not mix old and new batteries.
(b) Do not mix alkaline, standard (carbon-zinc) or rechargeable (nickel-cadmium) batteries.
3. If the unit is not to be used for an extended period of time, remove the batteries. Old or leaking batteries can cause damage to the unit and may void the warranty.
4. Do not dispose of batteries in fire, batteries may explode or leak.
5. Do not try to recharge batteries not intended to be recharged; they can overheat and rupture.(Follow battery manufacturer's directions).
6. Dispose the old batteries in accordance with the local regulation.

USING THE BELT CLIP

The supplied BELT CLIP allows you to attach the SAB-55A on your belt for convenient use.

1. Attaching the BELT CLIP

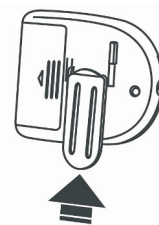

2. Removing the BELT CLIP

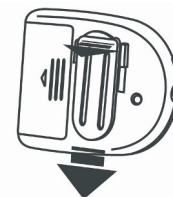

USING THE ARMBAND

With the supplied ARMBAND, you can wear your unit on arm for convenient use.

1. Attaching the ARMBAND to the BELT CLIP

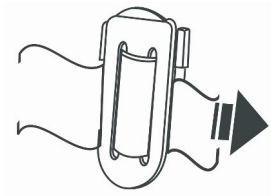

2. Attaching the BELT CLIP to your unit

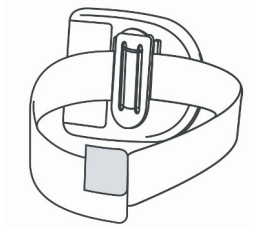

3. Adjusting the ARMBAND

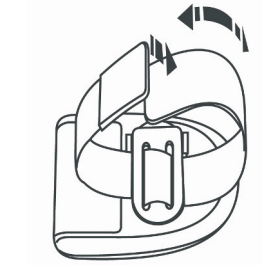

4. Wear on arm

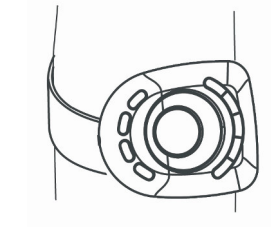

Note: After fitting the band to your arm, the excess could be cut off to avoid rubbing under arm during physical activity.

SETTING THE CLOCK TIME

1. When you replace the batteries, the unit will automatically switch into time setting and the time will blink. Or press and hold the POWER/BAND BUTTON (#1) to switch the SAB-55A to standby mode.
2. Press and hold MEM/TIME BUTTON (#9), the hour digits on the display will blink

3. Within seven seconds, press the TUNER UP (#7) / TUNER DOWN BUTTON (#6) repeatedly until the correct hour is reached.
4. Press the MEM/TIME BUTTON (#9) again and the minute digits on the display will blink.
5. Within seven seconds, press the TUNER UP BUTTON (#7) / TUNER DOWN BUTTON (#6) repeatedly until the correct minute is reached.
6. Press the MEM/TIME (#9) to confirm the time.

Note:

Make sure the hour is set so that AM or PM is correctly displayed. If the PM INDICATOR (#22) is showing on the display, the displayed time is "PM". If the AM INDICATOR (#22) is showing on the display, the time displayed is "AM".

RADIO OPERATION

1. Insert the earbuds into the EARPHONE JACK (#12) and press and hold the POWER / BAND BUTTON (#1) to turn on the radio.
2. Press the POWER / BAND BUTTON (#1) repeatedly to select AM or FM.
3. Press and hold the TUNER UP BUTTON (#7) / TUNER DOWN BUTTON (#6) to search next / previous available station. If the reception is poor, try Manual Tuning to fine-tune the station. Press the TUNER UP BUTTON (#7) / TUNER DOWN BUTTON (#6) briefly to manually tune through the frequency band.
4. Adjust the VOLUME UP/DOWN BUTTONS (#5/#4) to obtain the desired sound level.
5. Press the BASS BUTTON (#3) to enhance the bass effect of the music being played. Press the BASS BUTTON (#3) again to turn the effect off.
6. Press and hold the POWER / BAND BUTTON (#1) to turn off the SAB-55A when finish listening. The SAB-55A will display the time.

TIPS FOR BEST RECEPTION

FM - The FM radio uses the cord from the earbuds as the antenna. Unwrap and extend the cord for best reception. The FM STEREO INDICATOR will show on the display when receiving a stereo broadcast and signal is strong enough.

AM - The AM antenna is located inside the cabinet of the unit. If AM reception is weak, change the position of the SAB-55A until the internal antenna picks up the strongest signal.

Setting the Radio Station presets

The SAB-55A allows you to store up to 10 FM stations and 10 AM stations for easy recall at any time.

1. In the FM or AM mode, tune to the radio station you want to store in memory by using the TUNER UP BUTTON (#7) / TUNER DOWN BUTTON (#6).
2. Press STORE/ALARM BUTTON (#8). The MEMORY INDICATOR (#20) and the PRESET CHANNEL NUMBER (#21) will BE flashing on display.
3. To change the preset channel number location, press the TUNER UP BUTTON (#7) / TUNER DOWN BUTTON (#6) to step through the preset locations (1 – 10).
4. To confirm the preset location, press the STORE/ALARM BUTTON (#8).
- 5.) To store up to 100 FM and 10AM station presets, repeat steps 1 to 4 above.

Recalling the Preset Radio Stations

1. Set the SAB-55A to Radio FM or AM mode.
2. Press the MEMORY / TIME BUTTON (#9) repeatedly to select the desired preset station.

ALARM OPERATION

The SAB-55A has an alarm that will wake you up with a beeping sound. The alarm beeper is built into the case so it is not necessary to connect earphones to hear the alarm.

1. In Standby mode, press and hold the STORE/ALARM BUTTON (#8), the Hour digits of the alarm time will blink and the ALARM INDICATOR  will show on the display.
2. Within three seconds, press the TUNER UP BUTTON (#7) / TUNER DOWN BUTTON (#6) until the correct hour is reached.
3. Press the STORE/ALARM BUTTON (#8) again and the minute digits of alarm time will blink.
4. Within three seconds, press the TUNER UP BUTTON (#7) / TUNER DOWN BUTTON (#6) until the correct minute is reached.
5. Press the STORE/ALARM BUTTON (#8) to confirm the alarm time.
6. The Alarm will sound for 1 minute at the time you entered.

TO STOP THE ALARM SOUND

When alarm sounds, press any button (except STORE/ALARMARM BUTTON #8) once to stop the alarm and it will repeat next day same time.

TO COMPLETELY TO TURN OFF ALARM (NOT RESET FOR NEXT DAY)

In standby mode, press the STORE/ALARMARM BUTTON (#8) repeatedly until the ALARM INDICATOR  (#24) disappear.

LOCK FUNCTION

To prevent accidental function changes during active use, this unit is fitted with a function lock. After the unit has been powered on and the required station tuned, press the LOCK BUTTON (#2) to lock all functions. LOCK INDICATOR (#19) will show on the display.

CARE AND MAINTENANCE

1. Clean your unit with a damp (never wet) cloth. Solvent or detergent should never be used.
2. Avoid leaving your unit in direct sunlight or in hot, humid, or dusty places.
3. Keep your unit away from heating appliances and sources of electrical noise such as fluorescent lamps or motors.

CAUTION : Never allow any water or other liquids to get inside the unit while cleaning.

SPECIFICATION

Power Supply :	DC 3V 2 x AAA (UM4) Batteries (not included)
Frequency :	FM 87.5 - 108 MHz AM 520 -1710 KHz
Earphone :	32 ohms

* Design and specifications are subject to change without notice.

SPECTRA GREEN NOTICE



At Spectra, environmental and social responsibility is a core value of our business. We are dedicated to continuous implementation of responsible initiatives with an aim to conserve and maintain the environment through responsible recycling.

Please visit us at <http://www.spectraintl.com/green.htm> for more information on Spectra's green initiatives or to find a recycler in your area.

90 DAY LIMITED WARRANTY AND SERVICE VALID IN THE U.S.A. ONLY

SPECTRA MERCHANDISING INTERNATIONAL, INC. warrants this unit to be free from defective materials or factory workmanship for a period of 90 days from the date of original customer purchase and provided the product is utilized within the U.S.A. This warranty is not assignable or transferable. Our obligation under this warranty is the repair or replacement of the defective unit or any part thereof, except batteries, when it is returned to the SPECTRA Service Department, accompanied by proof of the date of original consumer purchase, such as a duplicate copy of a sales receipt.

You must pay all shipping charges required to ship the product to SPECTRA for warranty service. If the product is repaired or replaced under warranty, the return charges will be at SPECTRA's expense. There are no other express warranties other than those stated herein.

This warranty is valid only in accordance with the conditions set forth below:

1. The warranty applies to the SPECTRA product only while:
 - a. It remains in the possession of the original purchaser and proof of purchase is demonstrated.
 - b. It has not been subjected to accident, misuse, abuse, improper service, usage outside the descriptions and warnings covered within the user manual or non-SPECTRA approved modifications.
 - c. Claims are made within the warranty period.
2. This warranty does not cover damage or equipment failure caused by electrical wiring not in compliance with electrical codes or SPECTRA user manual specifications, or failure to provide reasonable care and necessary maintenance as outlined in the user manual.
3. Warranty of all SPECTRA products applies to residential use only and is void when products are used in a nonresidential environment or installed outside the United States.

This warranty gives you specific legal rights, and you may also have other rights which vary from state to state. TO OBTAIN SERVICE please remove all batteries (if any) and pack the unit carefully and send it freight prepaid to SPECTRA at the address shown below. IF THE UNIT IS RETURNED WITHIN THE WARRANTY PERIOD shown above, please include a proof of purchase (dated cash register receipt) so that we may establish your eligibility for warranty service and repair of the unit without cost. Also include a note with a description explaining how the unit is defective. A customer service representative may need to contact you regarding the status of your repair, so please include your name, address, phone number and email address to expedite the process.

IF THE UNIT IS OUTSIDE THE WARRANTY PERIOD, please include a check for \$8.00 to cover the cost of repair, handling and return postage. All out of warranty returns must be sent prepaid.

It is recommended that you contact SPECTRA first at 1-800-777-5331 or by email at custserv@spectraintl.com for updated information on the unit requiring service. In some cases the model you have may be discontinued, and SPECTRA reserves the right to offer alternative options for repair or replacement.

SPECTRA MERCHANDISING INTERNATIONAL, INC.
4230 North Normandy Avenue,
Chicago, IL60634, USA.
1-800-777-5331

To register your product, visit the link on the website below to enter your information.
<http://www.spectraintl.com/wform.htm>

0615

Printed in China