

JENSEN®

Docking Digital Clock Radio Music System For iPod®



OWNER'S MANUAL

JiMS-182

(iPod not included)

Please read this Instruction Manual carefully before using the unit and retain it for future reference

IMPORTANT INSTRUCTIONS

1. Do not install the system near any heat sources such as radiators, heat registers, stoves, or other apparatus (including amplifiers) that produce heat.
2. Protect the power cord from being walked on or pinched particularly at plugs, convenience receptacles, and the point where they exit from the apparatus.
3. Only use attachments / accessories specified in these instructions.
4. Unplug this apparatus during lightning storms or when unused for long periods of time.
5. Refer all servicing to qualified service personnel. Servicing is required when the apparatus has been damaged in any way, such as power-supply cord or plug is damaged, liquid has been spilled or objects have fallen into the apparatus, the apparatus has been exposed to rain or moisture, does not operate normally, or has been dropped.
6. This appliance shall not be exposed to dripping or splashing water and that no object filled with liquids such as vases shall be placed on the apparatus.
7. Do not attempt to dismantle, open or repair this product yourself. If a fault occurs, seek advice from your local qualified service technician or contact the distributor via the telephone number at the back of this instruction manual.

FCC NOTICE:

This equipment has been tested and found to comply with the limits for a Class B digital device, pursuant to Part 15 of the FCC Rules. These limits are designed to provide reasonable protection against harmful interference in a residential installation. This equipment generates, uses and can radiate radio frequency energy and, if not installed and used in accordance with the instructions, may cause harmful interference to radio communications.

However, there is no guarantee that interference will not occur in a particular installation. If this equipment does cause harmful interference to radio or television reception, which can be determined by turning the equipment off and on, the user is encouraged to try to correct the interference by one or more of the following measures:

- Reorient or relocate the receiving antenna.
- Increase the separation between the equipment and receiver.
- Connect the equipment into an outlet on a circuit different from that to which the receiver is needed.
- Consult the dealer or an experienced radio/TV technician for help.

WARNING:

Changes or modifications to this unit not expressly approved by the party responsible for compliance could void the user's authority to operate the equipment.

IMPORTANT NOTES

Avoid installing the unit in locations described below:





- Places exposed to direct sunlight or close to heat radiating appliances such as electric heaters.
- Dusty, humid or moist places.
- Places subject to constant vibration.

PROTECT YOUR FURNITURE

This system is equipped with non-skid rubber 'feet' to prevent the product from moving when you operate the controls. These 'feet' are made from non-migrating rubber material specially formulated to avoid leaving any marks or stains on your furniture. However certain types of oil based furniture polishes, wood preservatives, or cleaning sprays may cause the rubber 'feet' to soften, and leave marks or a rubber residue on the furniture.

To prevent any damage to your furniture we strongly recommend that you purchase small self-adhesive felt pads, available at hardware stores and home improvement centers everywhere, and apply these pads to the bottom of the rubber 'feet' before you place the product on fine wooden furniture.

LOCATION OF CONTROLS

1.  POWER/STANDBY Button
2. FUNCTION Button
3. MEMORY/SET Button
4. ALARM1 / M- Button
5. ALARM2/ M+ Button
6. SLEEP Button
7. iPod Connector
8.  Button
9. BAND /  Button
10.  Button
11. LIGHT Button
12.  Button
13. DISPLAY
14. LAMP
15. Battery Compartment
16. Release Button
17. AUX IN Jack
18. DC Jack
19. Lithium Battery Compartment

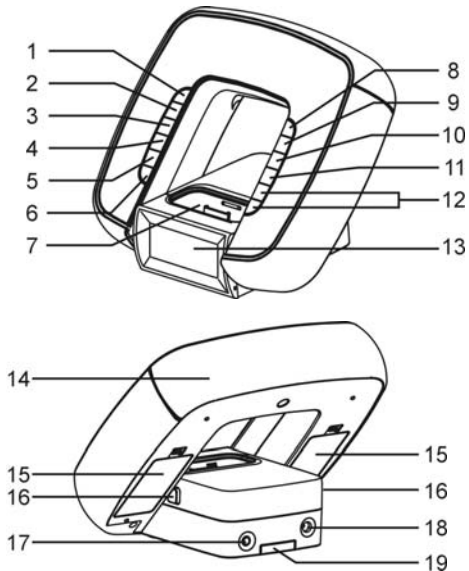

Display Segment



SETTING UP AND CONNECTING

This Portable Docking System is designed to operate on 4 x 1.5V 'AA' (UM-3) batteries (Not included) or the included AC Adaptor. A Lithium battery (Included) is also required for the backup of the clock.

A. BATTERY OPERATION

For outdoor or portable use, install 4 brand new, good quality alkaline-type batteries. Remove the battery doors on bottom of the cabinet.

1. Check the polarities and install 4 "AA" size (UM-3) batteries correctly.
2. Replace the battery doors.

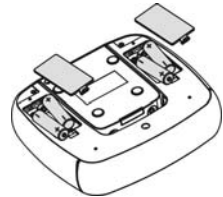

IMPORTANT:

- i. Be sure that the batteries are installed correctly. Wrong polarity may damage the unit and void the warranty.
- ii. For indoor use we recommend you remove all batteries and use the included AC adaptor.

BATTERY CARE

- I. Do not mix old and new batteries.
- II. Do not mix alkaline, standard (carbon-zinc) or rechargeable (nickel-cadmium) batteries.
- III. Replace the battery only with the same or equivalent type.
- IV. If the unit is not to be used for an extended period of time, remove the battery. Old or leaking battery can cause damage to the unit and may void the warranty.
- V. Do not dispose batteries in fire. Batteries may leak or explode.

BATTERY REPLACEMENT

The batteries are weak and need to be replaced when the sound becomes distorted, the Lamp or the Display starts flashing. You need to replace all the exhausted

batteries at the same time as soon as possible to avoid battery leakage.

B. AC Adaptor Operation

1. Insert one end of the AC adaptor into the DC Jack on back of JiMS-182.
2. Connect the AC plug of the AC adaptor to an AC 120V~ 60Hz power source.

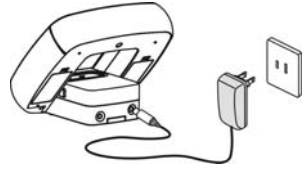

Note: The batteries will be automatically disconnected when the AC adaptor is plugged into the DC Jack and the System will operate on AC power.

Note: *Unplug the AC adaptor and disconnect the DC Jack when the JiMS-182 is not in use for a long period of time.*

C. ACTIVATING THE BACKUP FUNCTION

To activate the backup function of the system remove the Battery Insulation Tag from the backup battery compartment.

Replacing the Lithium Battery

1. Remove the battery tray located on the back of the unit.
2. Replace the exhausted “CR2025” 3V lithium battery with a new one with the “+” side facing upward.
3. Slide the battery tray back into the unit.

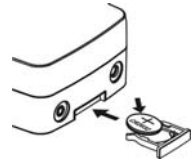

IMPORTANT: Be sure that the battery is installed correctly. Wrong polarity may damage the unit and void the warranty.

Tilting the Speaker Body up or down

The speaker body can be lifted up to face forward at about a 45 degree angle. Press down on the two Release Buttons located on both sides of the main body to lay the speaker body down flat.



SETTING THE CURRENT TIME

Current Time Setting

When first plugged in the display will show “12:00” after power up. The following example shows the procedure for setting the clock time to 8:20 AM.

1. The dock display will show “12:00” when first plugged in.



Press the **MEMO./SET** button once. "12H" will appear and flash in the display.

2. Press **◀◀** or **▶▶** button once to select 24 Hour format (24 H) if desired.
3. Press the **MEMO./SET** button again to save the hour format setting. The Hour digit will blink.
4. While the Hour digit blinks, press **◀◀** or **▶▶** button repeatedly to set the current hour.



Note: For 12 Hour format, make sure the Hour is correctly set so that AM or PM is correctly displayed.

5. Press the **MEMO./SET** button again to save the hour setting. The minute digit will blink.
6. While the Minute Digit blinks, press **◀◀** or **▶▶** button repeatedly to set the current minutes.
7. Press the **MEMO./SET** button again to complete the setting.



TUNER OPERATION

1. Press the **⏻ POWER/STANDBY** button once. The System will enter the FM mode.
2. Press the **▶|| BAND** button once to switch to AM if desired.



TO:	PRESS:
Switch between AM/FM band	▶ / BAND Button
Scan radio station manually	◀◀ or ▶▶ repeatedly
Scan radio station automatically	◀◀ or ▶▶ and hold for 2 seconds
Stop auto-tuning	◀◀ or ▶▶ once
Control the volume	◀+ / ▶- Buttons

TO PRESET CHANNELS

This unit is equipped with 20 preset memories each for AM and FM. Once they are preset, they can be instantly accessed by briefly pressing the **ALM.1/ MEM-** or **ALM.2/MEM+** Buttons.

1. Press the **⏻ POWER/STANDBY** button to turn the System on.
2. Press the **BAND / ▶||** button to switch between AM or FM band.
3. Tune to a desired station.
4. Press the **MEMO./SET** Button once. The Preset Channel number will appear and the Program Indicator "M" will also appear and flash in the Display.
5. While the Program Indicator "M" is blinking, repeatedly press the **ALM.2/MEM+** or **ALM.1/ MEM-** Button to select the desired preset channel.
6. While the Program Indicator "M" is blinking, briefly press the **MEMO./SET** button again to complete.
7. Tune to another station and repeat steps 4 to 6 to store stations in other preset locations.

TO RECEIVE PRESET STATIONS

1. Press the **⏻ POWER/STANDBY** button to turn the unit on.
2. Press the **▶|| BAND** button to select AM or FM band as desired.
3. Briefly press the **ALM.2/MEM+** or **ALM.1/ MEM-** Button to select the preset channels.

TIPS FOR BEST RECEPTION

1. Automatic tuning depends on the signal strength of the broadcasting station, so weak stations are sometimes skipped. Tune manually to find the weak stations. With stronger broadcast stations the tuner may stop before it reaches the station frequency or optimum reception. Tune manually for the best reception.
2. The receiver has a built-in bar antenna. If AM reception is weak, slightly rotating or re-positioning the unit will usually improve the reception. Please also remove the iPod from the docking bay as this will definitely improve the AM reception.



NOTE: For best AM reception, please completely unwrap the power adaptor cord and fully extend it keeping the adaptor as far from the radio as possible.

AUX OPERATION

You can play other music sources (iPod shuffle (1st and 2nd generation), MP3, CD or other digital audio player) through the speakers of JiMS-182 by connecting the AUX IN Jack to your external player's LINE OUT jack or headphone jack.

1. Plug one end of the connection cord (Not included) into the AUX IN jack on the back of JiMS-182. Plug the other end of the cord into your external audio player, such as an iPod shuffle, CD, MP3 Player etc.
2. Power on JiMS-182 and the external player.
3. Press the FUNCTION Button to select the AUX mode.
4. Start playing your iPod shuffle, MP3, CD or other digital audio player.
5. Slowly adjust both the volume on JiMS-182 and the external device.
6. Press the EQ Button repeatedly to choose the desired equalizer effect.
7. Turn off the attached player when finish listening.
8. Press the **⏻ POWER/STANDBY** Button to turn JiMS-182 off and unplug the connection cord from the AUX IN jack.



iPod ADAPTORS

There are three iPod Adaptors included in the package. One for the iPod touch (2nd generation) and iPod nano 3rd generation and 4th generation.

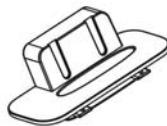

For nano 3rd generation

For nano 4th generation

For iPod 2nd generation

It is always recommended you use the adaptor that comes with your iPod first. This will help maximize a custom fit for your iPod when docked.

To place the iPod adaptor

1. Select an adaptor and gently place it into the dock. Insert the hooks of the adaptor into the socket of the docking bay.
2. Carefully push forwards and press down the adaptor.



To remove/replace the iPod adaptor

1. Gently remove your iPod upwards.
2. Push the iPod adaptor backwards and gently pull upwards.

DOCKING YOUR iPod

1. Press the POWER/**STANDBY** Button to turn on the unit.
2. Press the **FUNC.** Button to select iPod mode.
3. Select a suitable adaptor (included) or use the one that comes with your iPod and insert it into the docking bay. Your iPod can now be inserted onto the docking connector by aligning the connector on the bottom of the iPod onto the connector in the docking bay.
Note : Please be careful when seating your iPod onto the dock to avoid damaging the 30-pin connector in the iPod or the docking system.
4. The iPod will start playing and charging automatically.
Note: The iPod will only charge when the JiMS-182 is using the AC adaptor.
5. Adjust the sound level by pressing the / Buttons on the JiMS-182.
Note : The volume level cannot be adjusted using the volume control on your iPod after being docked.
6. Press the or Buttons to skip to the previous or next song.
7. Press and hold the or Buttons to fast-backward or fast-forward during playback.
8. To remove the iPod from JiMS-182, press and hold the Button for few seconds to switch off the iPod and then gently remove it from the docking connector.
9. To turn JiMS-182 off, press the POWER/**STANDBY** Button again.

ALARM OPERATION

Your JiMS-182 provides two different wakeup times, ALARM1 and ALARM2. You can choose to use them independently or simultaneously: ALARM 1, ALARM 2 or both ALARM 1 and ALARM 2.

Alarm Time Setting

Note: Alarm time (s) can only be set in Power Off mode.

1. To set the wakeup time, press and hold the **ALM.1 / MEM-** or **ALM.2 / MEM+** Button for approximately 3 seconds until the hour digit blinks. While the hour digit blinks, press **◀◀** or **▶▶** button to adjust your desired hour digit.

Note: For the 12 Hour format, Make sure the Hour is set so that AM or PM is correctly displayed.



2. Press **ALM.1 / MEM-** or **ALM.2 / MEM+** button to save the hour setting, the minute digit will blink.
3. While the minute digits blink, press **◀◀** or **▶▶** button to adjust your desired minute digit.
4. Press **ALM.1 / MEM-** or **ALM.2 / MEM+** button to save the wakeup setting.





Setting Wakeup Mode

Press **ALM.1 / MEM-** or **ALM.M2 / MEM+** Button repeatedly to select the desired wake up mode (wake to Alarm, RADIO or iPod) for alarm 1 or alarm 2.



1. Wake to Alarm

- Repeatedly press **ALM.1 / MEM-** or **ALM.2 / MEM+** Button to enter ALARM mode. “” or “” will appear in the display. Two different rings for Alarm 1 and Alarm 2 will sound when the alarm time is reached.

2. Wake to Radio

- Repeatedly press **ALM.1 /MEM-** or **ALM.2 / MEM+** Button to enter the RADIO mode, “” or “” will appear in the display.
- Follow the procedure in “**TUNER OPERATION**” to select your desired radio station.
- Press the **⏻ POWER/STANDBY** Button to turn off the unit. The radio will automatically turn on when the alarm time is reached.

3. Wake to iPod

- Briefly press **ALM.1 / MEM-** or **ALM.2 / MEM+** Button to select iPod mode, “” or “” will appear in the display.
- Follow the procedure in “**DOCKING YOUR IPOD**” to play your iPod.
- Press **⏻ POWER/STANDBY** Button to turn the unit off. When the alarm time is reached, the iPod will automatically start playing.

Note:

- i. After waking to iPod or Radio alarm, the volume level of the iPod or radio can be adjusted as needed.
- ii. After the alarm is on, the LCD backlight will automatically be set to high.

4. Light

- The light located on the top of the JiMS-182 works with all “Wake to” settings. The light will begin to light one minute before the alarm time is reached and will increase to full brightness by the time the alarm time is reached.

Stopping the Alarm

The alarm is programmed to continuously sound for 60 minutes. To stop the alarm, follow the directions below.

1. **SNOOZE / DIMMER** Button – Press this button to stop the alarm temporarily. The alarm will stop and automatically resume after 9 minutes.
2. **⏻ POWER/STANDBY** Button – Press this Button to stop the alarm which will sound again 24 hours later.
3. **ALM.1 / MEM-** or **ALM.2 / MEM+** Button – Press this Button once to stop the alarm and the alarm will sound again 24 hours later.

DIMMER Operation (With AC Adaptor plugged in)

In power off mode, press the **SNOOZE / DIMMER** Button repeatedly to adjust the LCD backlight to low, middle or high as desired.

Note:

- i. With the AC Adaptor plugged in and with power off, press any button except **SNOOZE/DIMMER** and the LCD backlight will automatically set to high and resume to the preset brightness in approximately 5 seconds.
- ii. If using battery power, the LCD backlit is always set to the dimmest level in order to conserve battery power. Press any button the LCD backlight will automatically set to high and resume to the dimmest level in approximately 5 seconds.

Turning the Lamp On/Off

1. You can press the **LIGHT** button to turn the **Lamp** on and off.
2. The **Lamp** will also light automatically one minute before the alarm time is reached and increase to the full brightest level when the alarm time is reached.
3. When you stop the alarm by pressing the **SNOOZE/DIMMER**, **⏻ POWER**, **ALM.1/MEM-** or **ALM.2/MEM+** Button, the **Lamp** will be turned off at the same time. You can also press the **LIGHT** Button to turn off the **Lamp** directly.
4. If the **Lamp** is on before waking to alarm, radio or iPod, when you stop the alarm by pressing the **SNOOZE/DIMMER**, **⏻ POWER/STANDBY**, **ALM.1/MEM-** or **ALM.2/MEM+** Buttons, the **Lamp** will remain on. To turn the **Lamp** off press the **LIGHT** Button once.

SLEEP OPERATION

Your JiMS-182 can be programmed to turn off according to your preset sleep time. The sleep time can be set for 15, 30, 60, 90 or 120 minutes.

Turn on the JiMS-182 on and select either iPod, Radio or AUX function.

1. Press the **SLEEP** Button repeatedly until the desired sleep time is shown on the Display. For example, if it is 10:00 PM and you set the sleep time for 30 minutes, the display will show:



Preset Sleep Time



Current time

2. The JiMS-182 will play and turn off automatically after the 30 minute Sleep time expires at 10:30 PM. If you want to cancel the sleep time before the time expires, press **POWER/STANDBY** Button once.
3. The Light can also be used during the Sleep mode. Press the **LIGHT** Button once to turn on the Light. The light will dim and go off when the preset sleep time expires.

Note: In AUX Mode, if the playing time of the external device is shorter than your selected sleep time, the music will stop when the external device shuts off.

CARE AND MAINTENANCE

1. Clean the unit with a damp (never wet) cloth. Solvent or detergent should never be used.
2. Avoid leaving your unit in direct sunlight or in hot, humid or dusty places.
3. Keep your unit away from heating appliances and sources of electrical noise such as fluorescent lamps or motors.
4. For better Clock Display clarity, avoid operating the unit under direct sunlight or in strong room illumination.

TROUBLESHOOTING GUIDE

Should the system exhibit a problem, please check the following before seeking service.

Symptom	Possible Cause	Solution
Radio		
Noise or sound distorted on AM or FM broadcasting.	Station is not tuned properly for AM or FM.	Fine-tune the AM or FM broadcast station.
	FM: The broadcast station signal is weak	Find another station or relocate the unit until the best reception is obtained.
	AM: The location of the built-in antenna is not correct.	Remove your iPod and rotate the unit until the best reception is obtained.
AM or FM no sound	Unit is not in RADIO function mode	Press the FUNC. Button repeatedly to select the RADIO mode.
	Volume is at minimum	Increase Volume level
iPod		
iPod will not play	Unit is not in iPod mode	Press the FUNC. Button to select iPod mode.
	iPod is not inserted properly	Re-insert iPod again
Alarm		
No Alarm	Alarm is not activated	Check that Alarm indicator "A" or "B", "Y" or "Z" "1" or "2" appears in the Display.
	Incorrect Alarm time	Make sure AM or PM is set correctly.
Abnormal Operation		
Clock, iPod, Radio or AUX IN not functioning	Internal micro controller needs to be reset	Remove all the batteries (including backup battery CR2025), disconnect the AC adaptor and wait a few seconds for the built-in micro controller to reset.
Abnormal or no display	Internal micro controller needs to be reset	Remove all the batteries (including backup battery CR2025), disconnect the AC adaptor and wait a few seconds for the built-in micro controller to reset.

SPECIFICATIONS

GENERAL

Power source ----- DC 6V 2000mA AC adaptor (Included)
DC 6V, "AA" size (UM-3) battery x 4 (Not

included)
CR2025 x 1 (Included) for memory back-up

Dimension ----- 6-7/8(W) x 7-1/2(D) x 1-7/8(H) Inch/
174(W) x 190 (D) x 47(H) mm
Weight ----- 1.32 lb/0.6kg

TUNER SECTION

Frequency range ----- FM: 87.5- 108MHz
AM: 530-1710 KHz

AUDIO SECTION

Power Output ----- 2 x 1.5 W @10% THD per Channel
Speaker impedance ----- 4 ohms
AUX input sensitivity ----- 500 mV

ACCESSORIES

Instruction Manual ----- 1 pc
iPod dock adapter ----- 1 kit (Including nano 3rd generation, nano 4th generation and iPod touch 2nd generation.)



You can help protect the environment! Please remember to respect the local regulations: turn in any non-working electrical equipment to an authorized waste disposal centre.

iPod is a trademark of Apple Inc., registered in the U.S. and other countries. "Made for iPod" means that an electronic accessory has been designed to connect specifically to iPod and has been certified by the developer to meet Apple performance standards. Apple is not responsible for the operation of this device or its compliance with safety and regulatory standards.

90 DAY LIMITED WARRANTY AND SERVICE

VALID IN THE U.S.A ONLY

SPECTRA MERCHANDISING INTERNATIONAL, INC. warrants this unit to be free from defective materials or factory workmanship for a period of 90 days from the date of original customer purchase and provided the product is utilized within the U.S.A. This warranty is not assignable or transferable. Our obligation under this warranty is the repair or replacement of the defective unit or any part thereof, except batteries, when it is returned to the SPECTRA Service Department, accompanied by proof of the date of original consumer purchase, such as a duplicated copy of a sales receipt.

You must pay all shipping charges required to ship the product to SPECTRA for warranty service. If the product is repaired or replaced under warranty, the return charges will be at SPECTRA's expense. There are no other express warranties other than those stated herein.

This warranty is valid only in accordance with the conditions set forth below:

1. The warranty applies to the SPECTRA product only while:
 - a. It remains in the possession of the original purchaser and proof of purchase is demonstrated
 - b. It has not been subjected to accident, misuse, abuse, improper service, usage outside the descriptions and warnings covered within the owner's manual or non-SPECTRA approved modifications
 - c. Claims are made within the warranty period
2. This warranty does not cover damage or equipment failure caused by electrical wiring not in compliance with electrical codes or SPECTRA owner's manual specifications, or failure to provide reasonable care and necessary maintenance as outlined in the owner's manual.
3. Warranty of all SPECTRA products applies to residential use only and is void when products are used in a nonresidential environment or installed outside the United States.

This warranty gives you specific legal rights, and you may also have other rights which vary from state to state. TO OBTAIN SERVICE please remove all batteries (if any) and pack the unit carefully and send it prepaid by insured parcel post or UPS to SPECTRA at the address shown below. IF THE UNIT IS RETURNED WITHIN THE WARRANTY PERIOD shown above, please include a proof of purchase (dated cash register receipt) so that we may establish your eligibility for warranty service and repair of the unit without cost. Also include a note with a description explaining how the unit is defective. A customer service representative may need to contact you regarding the status of your repair, so include your name, address, phone number and e-mail address to speed the process.

IF THE UNIT IS OUTSIDE THE WARRANTY PERIOD, please include a check for **\$35.00** to cover the cost of repair, handling and return postage. All out of warranty returns must be sent prepaid.

It is recommended that you contact SPECTRA first at 1-800-777-5331 or by e-mail at info@spectraintl.com for updated information on the unit requiring service. In some cases the model you have may be discontinued and SPECTRA reserves the right to offer alternative options for repair or replacement.

SPECTRA MERCHANDISING INTERNATIONAL, INC.
4230 North Normandy Avenue,
Chicago, IL60634, USA.
1-800-777-5331

To register your product, visit the link below on the website to enter your information.
<http://www.spectraintl.com/wform.htm>

Printed in China

172-G4010A1020-

JEN