

JENSEN®

Docking Digital HD Radio™ System for iPod® and iPhone™

HD Radio®



Owner's Manual

JIMS-525i

(iPod and iPhone Not Included)

Please read and follow this Instruction Manual carefully before using the unit and retain it for future reference

IMPORTANT SAFETY INSTRUCTIONS

WARNING: TO REDUCE THE RISK OF FIRE OR ELECTRIC SHOCK, DO NOT EXPOSE THIS APPLIANCE TO RAIN OR MOISTURE. DANGEROUS HIGH VOLTAGES ARE PRESENT INSIDE THE ENCLOSURE. DO NOT OPEN THE CABINET REFER SERVICING TO QUALIFIED PERSONNEL ONLY.



The lightning flash and arrow head within the triangle is a warning sign alerting you of “dangerous voltage” inside the product

CAUTION

**RISK OF ELECTRIC SHOCK
DO NOT OPEN**

CAUTION: TO REDUCE THE RISK OF ELECTRIC SHOCK DO NOT REMOVE COVER (OR BACK) NO USER SERVICEABLE PARTS INSIDE. REFER SERVICING TO QUALIFIED SERVICE PERSONNEL



The exclamation point within the triangle is a warning sign alerting you of Important Instructions accompanying the product

The Caution marking is located at the bottom of the unit.

The rating plate is located at the bottom of the unit.

CAUTION:

PLEASE READ AND OBSERVE ALL WARNINGS AND INSTRUCTIONS GIVEN IN THIS OWNER'S MANUAL AND THOSE MARKED ON THE UNIT, KEEP THESE INSTRUCTIONS. RETAIN THIS BOOKLET FOR FUTURE REFERENCE.

This set has been designed and manufactured to assure personal safety. Improper use can result in electric shock or fire hazard. The safeguards incorporated in this unit will protect you if you observe the following procedures for installation, use and servicing. This unit does not contain any parts that can be repaired by the user.



The symbol for class II (Double insulation)

DO NOT REMOVE THE CABINET COVER, OR YOU MAY BE EXPOSED TO DANGEROUS VOLTAGE. REFER SERVICING TO QUALIFIED SERVICE PERSONNEL ONLY.

1. Read these Instructions.
2. Keep these Instructions.
3. Heed all Warnings.
4. Follow all instructions.
5. Do not use this apparatus near water.
6. Clean only with a dry cloth.
7. Do not block any of the ventilation openings. Install in accordance with the manufacturer's instructions.
8. Do not install near any heat sources such as radiators, heat registers, stoves, or other apparatus (including amplifiers) that produce heat.

IMPORTANT SAFETY INSTRUCTIONS

9. Do not defeat the safety purpose of the polarized or grounding – type plug. A polarized plug has two blades with one wider than the other. A grounding type plug has two blades and a third grounding prong. The wide blade or the third prong is provided for your safety. If the provided plug does not fit into your outlet, consult an electrician for replacement of the obsolete outlet.
10. Protect the power cord from being walked on or pinched particularly at plugs, convenience receptacles and the point where they exit from the apparatus.
11. Only use attachments/accessories specified by the manufacturer.
12. Use only with a cart, stand, tripod, bracket, or table specified by the manufacturer, or sold with the apparatus. When a cart is used, use caution when moving the cart/apparatus combination to avoid injury from tip-over.
13. Unplug this apparatus during lightning storms or when unused for long periods of time.
14. Refer all servicing to qualified service personnel. Servicing is required when the apparatus has been damaged in anyway, such as power-supply cord or plug is damaged, liquid has been spilled or objects have fallen into the apparatus, the apparatus has been exposed to rain or moisture, does not operate normally, or has been dropped.



FCC NOTICE:

This equipment has been tested and found to comply with the limits for a Class B digital device, pursuant to Part 15 of the FCC Rules. These limits are designed to provide reasonable protection against harmful interference in a residential installation. This equipment generates, uses and can radiate radio frequency energy and, if not installed and used in accordance with the instructions, may cause harmful interference to radio communications.

However, there is no guarantee that interference will not occur in a particular installation. If this equipment does cause harmful interference to radio or television reception, which can be determined by turning the equipment off and on, the user is encouraged to try to correct the interference by one or more of the following measures:

- Reorient or relocate the receiving antenna.
- Increase the separation between the equipment and receiver.
- Connect the equipment into an outlet on a circuit different from that to which the receiver is needed.
- Consult the dealer or an experienced radio/TV technician for help.

Warning:

Changes or modifications to this unit not expressly approved by the party responsible for compliance could void the user's authority to operate the equipment.

- The apparatus shall not be exposed to dripping or splashing and that no objects filled with liquids, such as vases, shall be placed on apparatus.
- Main plug is used as disconnect device and it should remain readily operable during intended use. In order to disconnect the apparatus from the mains completely, the mains plug should be disconnected from the mains socket outlet completely.
- Battery shall not be exposed to excessive heat such as sunshine, fire or the like.

TABLE OF CONTENTS

WELCOME	4
PROTECT YOUR FURNITURE	4
ABOUT THIS MANUAL	4
LOCATION OF CONTROLS	4
FRONT VIEW	4
REAR VIEW	5
DISPLAY UNIT	5
REMOTE CONTROL SECTION	6
GETTING STARTED	6
UNPACKING THE HD RADIO™ RECEIVER	6
CONNECTING THE FM ANTENNA WIRE	6
CONNECTING THE HD RADIO™ RECEIVER TO A CABLE RADIO SIGNAL	7
ANTENNA GROUNDING	7
NOTICE FOR CABLE TV SYSTEM INSTALLER	7
CONNECTING THE AM LOOP ANTENNA	7
AUX LINE-IN CONNECTION	7
CONNECTING AC POWER SUPPLY	8
ACTIVATING THE REMOTE CONTROL	8
REPLACING THE REMOTE CONTROL BATTERY	8
BATTERY PRECAUTIONS	8
RADIO OPERATION	9
LISTENING TO THE RADIO	9
TO PRESET CHANNELS	10
TO RECEIVE PRESET STATIONS	10
HD RADIO™ MULTICAST CHANNELS (FM ONLY)	10
SPECIAL INFORMATION ABOUT DELAY IN THE HD RADIO™ SYSTEM	11
RBDS (RADIO BROADCAST DATA SYSTEM)	11
iTunes Tagging	12
TO STORE SONG TAG(S)	12
PURCHASING SONG(S) WITH ITUNES	12
AUX OPERATION	13
iPod ADAPTORS	13
DOCKING YOUR IPOD	14
DOCKING YOUR IPHONE	15
CONNECTING THE S-VIDEO (FOR IPOD VIDEO OUTPUT)	16
GENERAL SET UP	16
FOR PHOTO VIEW (FOR IPOD WITH COLOR DISPLAY ONLY – EXCLUDING IPOD NANO)	16
CONNECTING THE S-VIDEO (FOR IPHONE VIDEO OUTPUT)	16
FOR VIDEO VIEW (FOR IPHONE WITH VIDEO ONLY)	16
USING HEADPHONES (NOT INCLUDED)	17
CLOCK SETTING	17
SETTING THE TIME	17
SETTING THE ALARM (S)	18
CLOCK LIGHT OPERATION	18
ALARM OPERATION	19
WAKE TO RADIO, IPOD OR ALARM	19
SNOOZE OPERATION	19
SLEEP OPERATION	20
SETTING SLEEP TIMER	20
ADJUSTING THE SLEEP PERIOD	20
SLEEP AND WAKE TO BUZZER/IPod/RADIO	20
CARE AND MAINTENANCE	21
CLEANING THE UNIT	21
SPECIFICATIONS	21
TROUBLESHOOTING GUIDE	22
SERVICE	23

WELCOME

Thank you for purchasing the JENSEN JiMS-525i HD Radio™ System.
Before operating the unit, please read this manual thoroughly and retain it for future reference.

PROTECT YOUR FURNITURE!!

This system is equipped with non-skid rubber 'feet' to prevent the product from moving when you operate the controls. These 'feet' are made from non-migrating rubber material specially formulated to avoid leaving any marks or stains on your furniture. However certain types of oil based furniture polishes, wood preservatives, or cleaning sprays may cause the rubber 'feet' to soften, and leave marks or a rubber residue on the furniture.

To prevent any damage to your furniture we strongly recommend that you purchase small self-adhesive felt pads, available at hardware stores and home improvement centers everywhere, and apply these pads to the bottom of the rubber 'feet' before you place the product on fine wooden furniture.

ABOUT THIS MANUAL

Instructions in this manual describe using the controls on the remote. You can also use the controls on the main unit if they have the same or similar names as those on the remote.

LOCATION OF CONTROLS

Front View

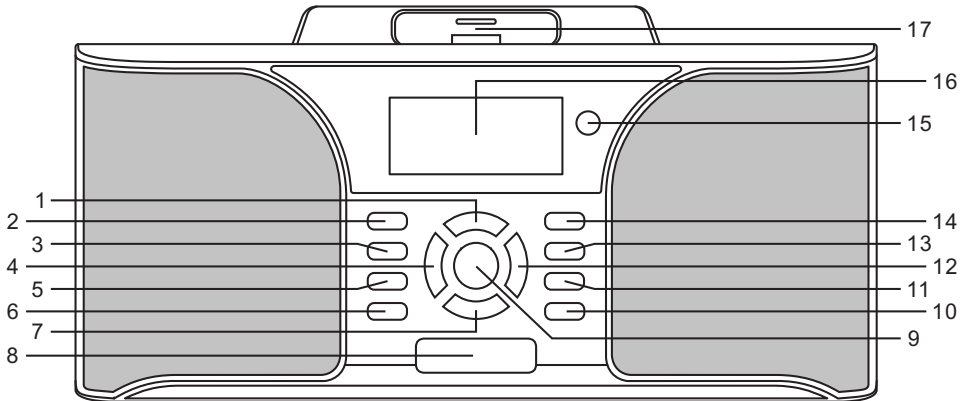

- | | |
|---------------------------------------|-------------------------------------|
| 1. Volume + Button | 10. ALARM 2 Button |
| 2. STANDBY/ON Button | 11. ALARM 1 Button |
| 3. EQ Button | 12. Skip ⏭ Forward/Tuning Up Button |
| 4. Skip ⏮ Backward/Tuning Down Button | 13. SLEEP Button |
| 5. FUNCTION Button | 14. SET/FM MODE Button |
| 6. BAND Button | 15. Remote Sensor |
| 7. Volume - Button | 16. Display |
| 8. SNOOZE/LIGHT Button | 17. iPod Connector and Docking Bay |
| 9. Play/Pause ⏸ / iTunes® Tag Button | |

LOCATION OF CONTROLS (Continued)

Rear View

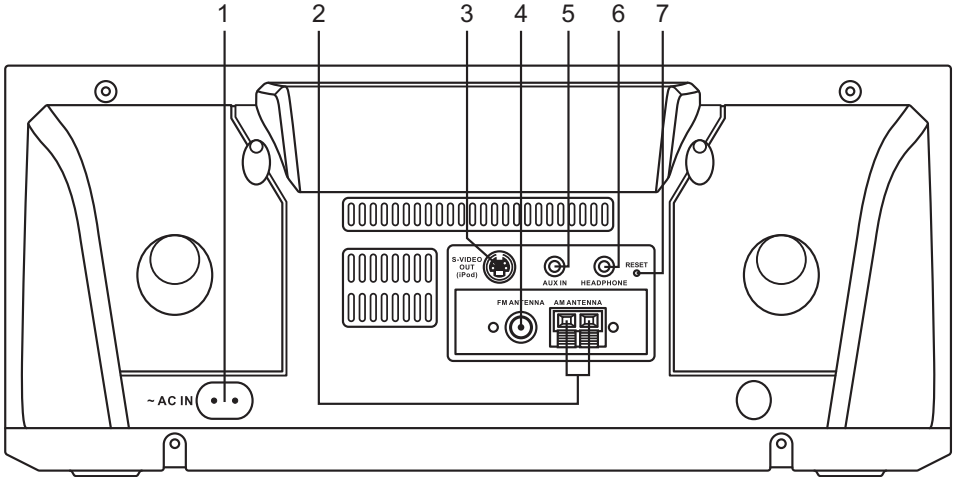

- | | |
|--|---------------------|
| 1. AC INPUT SOCKET | 5. AUX LINE-IN Jack |
| 2. AM Antenna Connector | 6. HEADPHONE Jack |
| 3. S-VIDEO Output (5 th Gen iPod) | 7. RESET Switch |
| 4. FM Antenna Connector | |

Display Unit

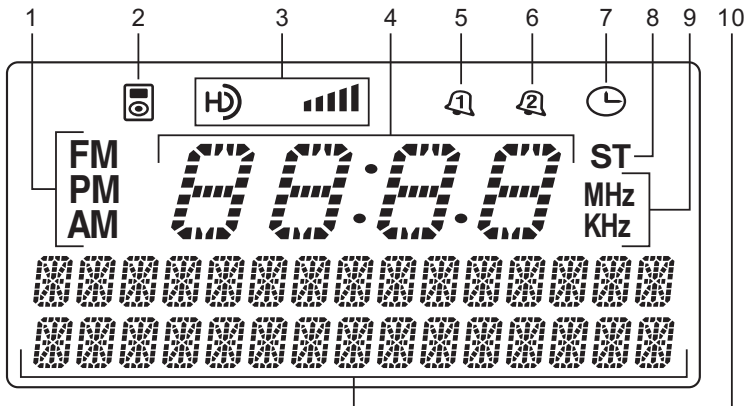

- | | |
|---------------------------|--------------------------------------|
| 1. Band/AM-PM Indicator | 6. ALARM 2 Indicator |
| 2. iPod Icon | 7. SLEEP Indicator |
| 3. HD Radio™ Icon | 8. FM STEREO Indicator |
| 4. Time/Frequency Reading | 9. Frequency Unit |
| 5. ALARM 1 Indicator | 10. RBDS Messages/FUNCTION Indicator |

LOCATION OF CONTROLS (Continued)

Remote Control Section

POWER	Turn the Radio On/Off
BAND	Select AM/FM Band
FUNCTION	Selects Radio, iPod or Aux Modes
0 – 9	Numeric buttons
PRESET STATIONS ▼	Memory Stations Down
PRESET STATIONS ▲	Memory Stations Up
EQ	Equalizer Options
MEMORY	Program Preset Stations
+, -	Volume Up and Down
▶ 	Play/Pause/ iTunes® Tag
▶▶	Skip Forward/Tuning Up
◀◀	Skip Backward/Tuning Down
SNOOZE/LIGHT	Silences the Alarm Temporarily/ Switch Backlight On/Off
MUTE	Mute the System Sound
SET/FM MODE	Set Time/Select FM ST or MONO
ALARM 1	Set Alarm 1
ALARM 2	Set Alarm 2
SLEEP	Set Sleep Timer On

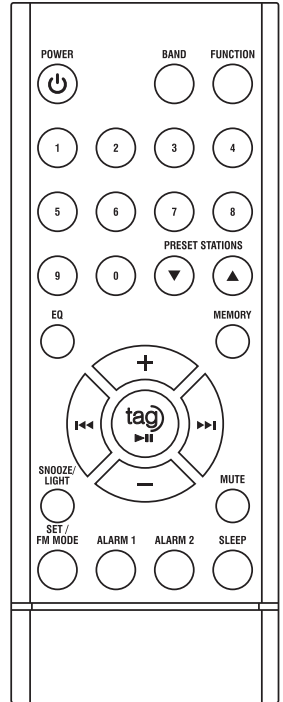

GETTING STARTED

Unpacking the HD Radio™ Receiver

Please save all the original packaging. It provides the safest way to transport your unit.

Note: This HD Radio™ Receiver is not designed for automotive use.

NOTE: The JiMS-525i is not magnetically shielded and may cause color distortion on the screen of some TVs or video monitors. To avoid this, you may need to move the unit further away from the TV or monitor if unnatural color shifts or image distortion occurs.

Connecting the FM Antenna Wire (included)

1. Push the connector plug on the end of the antenna wire onto the FM Antenna Connector at the rear of the radio.
2. Straighten out the Antenna to its full length and orient the wire for the best reception.

GETTING STARTED (Continued)

Connecting FM / HD Radio™ Receiver Antenna / to a Cable Radio Signal

This Radio's FM Antenna Connector is a standard connector that will accept either the FM Antenna wire (included) or the cable FM feed from most cable systems that provide FM programming. To connect the included FM Antenna wire, slide the black plastic end of the antenna wire onto the center post of the antenna connector on the back of the unit. To connect your Radio to the FM signal available from some cable TV providers, contact your cable TV provider for assistance and also to find out if HD Radio™ broadcast signals are available through the cable line. As of the writing of this manual, HD Radio™ signals are not being rebroadcast via cable providers.

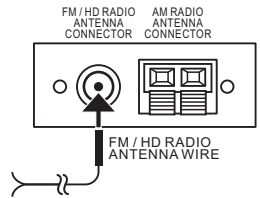

Be sure that the installation includes a splitter that will filter the signal to prevent any re-emission of the TV spectrum through the Radio, so that only the FM band, not the cable TV signal, is transmitted to the Radio.

Antenna Grounding

Example of antenna grounding, per the National Electrical Code, ANSI/NFPA 70.

Notice for Cable TV System Installer

Please make note of Article 820-40 of the NEC (of USA) that provides guidelines for proper grounding. In particular, this standard specifies that the cable ground shall be connected to the grounding system of the building, as close to the point of cable entry as is practical.

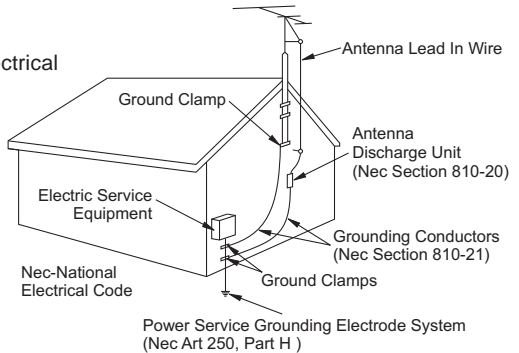

Connecting the AM Loop Antenna

If AM reception is weak for improvement connect the provided Loop Antenna as describe below:

1. Push to open the 2 receptacles of the AM antenna terminals and insert 2 open-end wires of the AM loop antenna into them.
2. Release the 2 AM antenna terminal handles to hold the AM loop antenna wires in place.
3. Orient the AM loop antenna for the best reception.

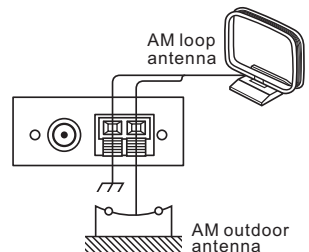

AUX LINE-IN Connection

Connect one end of the Audio line cable (Included) to the AUX Input jack at the back of the Radio and the other end of the Audio line cable to your external audio player, such as a CD, MP3 etc.

GETTING STARTED (Continued)

Connecting AC Power Supply

- This JiMS-525i HD Radio™ System operates from AC120V ~ 60Hz line power supply.
- The Remote Control operates on 1 Lithium battery, CR2025 (Included).

Insert the AC Cord Inlet into the AC cord socket on back of the Radio and the other end into a standard 120V AC outlet as shown in the diagram below.

The Radio will automatically go into standby mode.

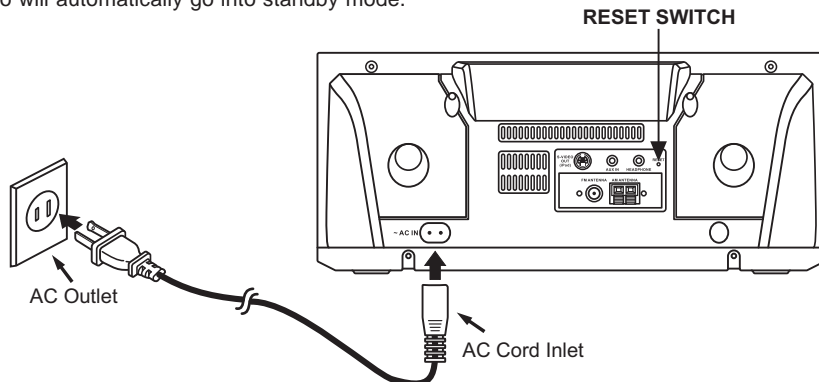

Remark:

In the event of a malfunction due to electrostatic discharge (ESD), reset the unit by pressing the RESET switch located on the back of the main unit with a ballpoint pen or similar object.

Activating the Remote Control

- To activate the Remote Control, remove the protective film.
- Point remote control toward the front of the main unit. The effective range of the remote is about 19 ft from the remote sensor and within an angle of about 45° from the front of the unit.

Replacing the Remote Control Battery

Please replace your battery if the operating distance of the Remote Control drops drastically.

1. Remove the battery cover.
2. Install one new CR2025 Lithium battery into the battery compartment as shown in the figure on the right.
3. Replace the cover.

Caution: The battery may leak or explode if incorrectly installed.

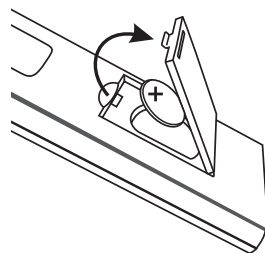

Battery Precautions

Follow these precautions when replacing the battery in this device.

1. Use only the size and type of battery specified.
2. Be sure to follow the correct polarity when installing the batteries as indicated next to the battery compartment. Reversed battery may cause damage to the device.
3. If the device is not to be used for a long period of time, remove the battery to prevent damage or injury from possible battery leakage.
4. Do not try to recharge. The battery is not intended to be recharged and can overheat and rupture. (Follow battery manufacturer's directions.)
5. Do not dispose of battery in fire, battery may explode or leak.

RADIO OPERATION

The following procedures can be accomplished by using either the remote or the controls on the main unit.

Listening to the Radio

Note: When entering the Radio function mode, the words "PLEASE WAIT TO TURN ON RADIO" will appear first on the bottom row of the Display and then the Band and Frequency Reading will be shown in the Display after one or two seconds.

1. Press the  Button to turn on the unit.
2. Press the FUNCTION Button to operate the unit in radio mode.



TO:	PRESS:
Switch between AM/FM band	BAND Button repeatedly
Select FM MONO or ST mode	SET Button repeatedly
Scan radio station automatically	»» or «« Hold Buttons for 1 second
Stop auto-tuning	»» or «« Buttons again
Scan radio station manually	»» or «« Buttons repeatedly
Control the volume	VOLUME + or – Buttons
Adjust the EQ	EQ Button repeatedly until the desired EQ shown in the Display
Stop output from the speakers	MUTE Button once
Resume output from the speakers	MUTE Button again

Note:

1. Frequency reading will change to the time 1 minute after the system has entered the radio function mode. The FM Stereo Indicator will stay on in the Display in FM stereo mode.
2. To check the station frequency, press the SET/FM MODE Button once and again in order to keep the station in stereo mode. Station frequency will be displayed for about 1 minute and revert to current time again.
3. When listening to an FM station, fully extend the antenna to insure maximum tuner sensitivity.
4. Automatic tuning depends on the signal strength of the broadcasting station, so weak stations are sometimes skipped. Tune manually to find the weak stations. With stronger stations, the tuner may stop before it reaches optimum setting for that station. Adjust manually for the best reception if needed.
5. For FM reception, the Radio provides FM MONO/STEREO selection. In stereo mode, the unit will automatically switch to stereo when a strong FM stereo broadcast is received and will indicate "ST" in the Display.
6. To receive a weaker (noisy) FM station, press the SET/FM MODE Button to switch to MONO mode. The reception may improve, but the sound heard is monaural (MONO).
7. The sound equalization can be adjusted for optimum sound reproduction depending on the style of music you are playing. By pressing the EQ button, you can switch between ROCK, POP, CLASSIC, JAZZ, BASS or NORMAL equalization to suit your taste.



RADIO OPERATION (Continued)

To Preset Channels

This Radio is equipped with 10 preset memories for AM and 20 preset memories for FM. Once they are preset, they can be instantly accessed by keying in the preset channel using the Numeric Buttons or pressing the ▲ or ▼ Buttons on the Remote Control.

1. Press ⏻ Button to turn on the unit.
2. Press the FUNCTION Button to switch the unit into radio mode.
3. Press the BAND Button to select AM or FM band as desired.
4. Tune to a desired station.
5. Press the MEMORY Button. Channel Indicator "01" appears and blinks.
6. While the Channel Indicator is blinking, press the ▲ or ▼ Buttons to select the desired preset channel.
7. Press the MEMORY Button again to confirm when the desired preset channel appears in the Display.
8. Tune to another station and repeat steps 5 to 7 to store a new station in another preset channel.

To Receive Preset Stations

1. Press ⏻ Button to turn on the unit.
2. Press the FUNCTION Button to operate the unit in the radio mode.
3. Press the BAND Button to select the AM or FM band as desired.
4. Press the ▲ or ▼ Buttons or key in the preset channels using the NUMERIC Buttons to select the preset channels.

Note: HD Radio™ Multicast Channels (HD2, HD3, etc) can be added to the preset memory locations for easy access, but there may be a delay before sound is heard when accessing the channels from memory. See the section below "Special Information about Delay in the HD Radio™ System" for more information on why this delay occurs.

HD Radio™ Multicast Channels (FM Only)

Together with digital sound quality, HD Radio™ technology gives broadcasters the opportunity to offer more than one programming channel simultaneously using their existing frequency on the radio tuning buttons.

If the HD Radio™ Receiver recognizes an HD Radio channel, the HD logo starts blinking until the signal is tuned in. After the HD Radio™ Receiver is tuned to an HD channel, CH1 will indicate the existence of multicast services. Use the ▲ or ▼ Buttons to select the multicast channels (i.e. CH2).

If you are listening to an HD Radio™ Multicast Channel (HD2, HD3, etc) and turn the radio power off or switch to either iPod or Aux modes, the radio will default back to the main non-HD radio station when the power is turned on again or if you switch back to the radio function. Example: You are listening to "97.9FM HD2" and turn the power off or change to iPod or Aux mode. When you turn the power back on or switch back to the radio mode, the station will be the 97.9FM and not the HD2 multicast channel. If an HD signal is detected the station will automatically switch to 97.9FM HD1, but you will manually need to change to 97.9FM HD2 if this is the channel you want to listen to again.

RADIO OPERATION (Continued)

Special Information about Delay in the HD Radio™ System

Digital systems inherently produce a delay in audio. To overcome such delay, HD Radio™ broadcasting uses a station's current analog signal to ensure fast tuning of an AM or FM station. After an estimated 5 seconds, the audio will change from analog to digital HD Radio™ broadcasting.

If the change is smooth, the radio station will implement the HD Radio™ broadcast correctly. But if the station has no smooth change, you will experience a jump in content of an estimated 5 seconds. The HD Radio™ Receiver is not a problem. It is an HD Radio™ broadcaster's implementation problem which could be corrected by the station through time.

Today's analog is only present on the main channel. If you tune directly to a station's multicast channel (CH2), there will have a delay of about 5 seconds before audio or content is heard. This operation is normal.

RBDS (Radio Broadcast Data System)

This Radio supports RBDS, Program Identification and Radio Text. This function allows a radio station to transmit free-form, static textual information. For example, station slogans are synchronized with the programming and the title and artist of currently-playing songs are displayed along with the radio program.

iTunes Tagging

Note: iTunes Tagging® for iPod - Compatibility with iPod nano (3rd generation), iPod classic and iPod (5th generation).

To Store Song Tag(s)

1. In Radio mode, "Tag Available" will appear on the display indicating that a song Tag is available for the song that is currently playing. Briefly press the **▶|** / Tag Button either on the main unit or on the remote control to capture the song information Tag. Message "Storing Tag" will appear in the Display.
2. The Radio will check if its internal memory is full or not. If the internal memory is full, the Display will show "Storage Full", and return to the previous display.
3. If the internal memory is not full, then the Radio will check if the radio station that is playing contains a buying tag or not. If a buying tag is not available, the Display will show "Insufficient Data", and return. If a buying tag is available, storage of that song tag will begin.
4. If the tag fails to be stored in the internal memory, the Display will show "Storage Failed", and return to the previous display.
5. If storage of the tag is successful, the Display will show "Storage Success". The number of tags stored will then be displayed, "Tag Stored: X", and balance of internal memory, "Free Space: X", will also be displayed.
6. Docking your iPod: When you first dock your iPod, The JiMS-525i will check for the version iPod you are using. "Reading iPod, "Please wait....." will be shown on the Display.
7. Authentication will begin. Display will show "iPod AUTHEN PLEASE WAIT....." If Authentication fails, the Display will show "Authentication Failed", and return to the previous display.
8. If authentication is successfully, data transmission will start. The Display will show "Transfer Tags Please wait....."
9. If the internal memory of the iPod is not adequate for the Tags being transferred, the LCD will show "Memory Not Enough", and return.
10. If internal memory is adequate to accept the Tags, the data transmitted to iPod will first be checked for correctness. If the data is not correct, the Display will show "XML Write Failed", and return to the previous display.
11. If data transmission is successful, the Display will show "X Tags Sent". X signifies the number of Tags.
12. The Tags are automatically erased from the internal memory of the JiMS-525i once they are transferred to the iPod.

Purchasing Song(s) with iTunes

1. Once the song Tags are stored on the iPod, you can now plug your iPod into your computer in the same manner as you normally would when accessing iTunes.
2. You will need to make sure you are using the latest software version for both your iPod and iTunes.
3. Once your iPod mounts and appears in the iTunes window, you click on the "Sync" button to sync your iPod with iTunes. **IMPORTANT:** Make sure you are working on the same computer you normally use for your iPod or make sure that iTunes is manually managing the content on your iPod otherwise you could wipe the content from your iPod and reload all the content from the iTunes library you are now sync'd with. See your iTunes Help section before pressing "Sync" if you have any doubts about working with Auto and Manual updating.
4. Once your iPod Syncs with iTunes, you will see a new tab on the left side of the screen called "Tagged Songs". All the songs you Tagged will show in this tab when selected.
5. You can now select a Tagged song from the screen and you will automatically be taken to the iTunes Store. Please note, you need an iTunes Store account in order to purchase Tagged songs, so see the information that came with your iPod for information on how to create an account for iTunes.
6. If the song cannot be found in iTunes, you can use the advanced search feature in iTunes to locate the songs manually.
7. Once a Tagged song is selected, you can now purchase the song through iTunes in the same way you would normally purchase songs.

AUX OPERATION

You can play other music sources (iPod shuffle, MP3, CD or other digital audio player) through the speakers of this Radio by connecting the AUX LINE-IN Jack to your external player's audio out jack or headphone jack.

1. Set up the Radio and your external player as described in the section AUX IN Connection.
2. Power up the Radio and the external player.
3. Press the FUNCTION Button to operate the Radio in AUX mode.
4. Start playing your MP3, CD or other digital audio player.
5. Press the + or – Buttons to obtain the desired sound level.
6. Press EQ Button to choose the desired equalizer effect.

iPod ADAPTORS

Below are the iPod Adaptors included in the package.

It is always recommended you use the adaptor that comes with your iPod first. This will help maximize a custom fit for your iPod when docked.

iPod Models	iPod Adaptor	
5 th Gen iPod with video 60GB & 80GB		
5 th Gen iPod & U2 iPod with video 30GB iTouch & iPhone		
iPod mini 4GB & 6GB		
1 st Gen iPod nano 1GB, 2GB & 4GB		
2 nd Gen iPod nano 2GB, 4GB & 8GB		

TABLE 1

DOCKING YOUR iPod

1. Press the **⏻** Button to turn on the unit.
2. Press the **FUNCTION** Button to select iPod mode.
3. According to TABLE 1, select a suitable adaptor for your iPod and insert it into the docking bay. Your iPod can now be inserted onto the iPod connector by aligning the connector on the bottom of the iPod onto the connector in the docking bay.

Note: Please be careful when seating the iPod onto the dock to avoid damaging the 30-pin connector in the iPod or the docking system.

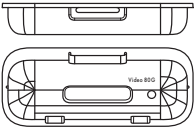
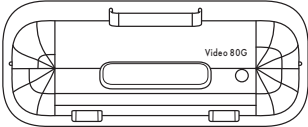
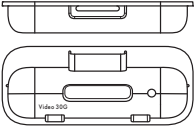
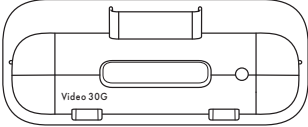
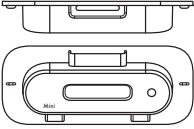
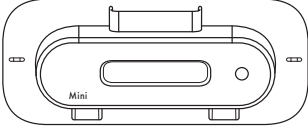
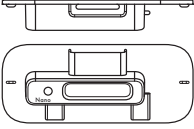
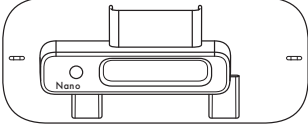
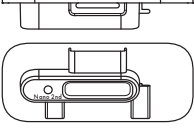
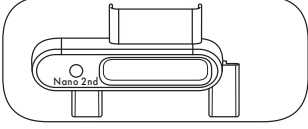
4. Authentication will begin once the iPod is docked. The message "IPOD AUTHEN PLEASE WAIT....." will be shown on the Display for a few seconds and then the type of iPod will be shown on the Display.

5. The iPod will start playing automatically and will also charge.

6. Adjust the sound level by pressing the **VOLUME +/-** buttons on the JiMS-525i.

Note: The volume level cannot be adjusted using the volume control on your iPod after being docked.

7. Press EQ Button on the JiMS-525i to choose the desired equalizer effect.

Note: Set the EQ of your iPod to OFF so that it will not affect the correct operation of the EQ on this unit.

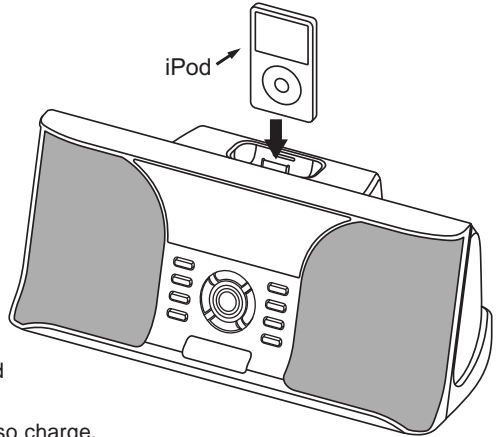

DOCKING YOUR iPhone

1. Press the **⏻** Button to turn on the unit.
2. Press the **FUNCTION** Button to select iPod mode.
3. According to TABLE 1, select the 30G adaptor and insert it into the docking area. Your iPhone can now be inserted into the docking port by aligning the connector on the bottom of the iPhone onto the connector in the docking.

Note: Please be careful when seating the iPhone onto the dock to avoid damaging the 30-pin connector in the iPhone or the docking system.

4. Authentication will begin once the iPhone is docked. The message "IPOD AUTHEN PLEASE WAIT" will be shown on the Display for a few seconds and then "iPhone" will be shown in the Display.
5. The iPhone will start playing iPod music automatically and will charge.

6. Adjust the sound level by pressing the **VOLUME +/-** buttons on the JiMS-525i.

Note: The volume level cannot be adjusted using the volume control on your iPhone after being docked.

7. Press EQ Button on the JiMS-525i to choose the desired equalizer effect.

Note: Set the EQ of your iPhone to OFF so that it will not affect the correct operation of the EQ on this unit.

8. Playback will be suspended if there is an incoming call. The iPhone will ring.

9. Touch the Answer icon once to pick up the call.

10. Touch the Speaker button once to answer the call in handsfree mode.

11. Press the End Call Icon when you have finished answering the call. Music will resume.

Note: To enhance sound quality in handsfree mode, you should always use the 30G adaptor for docking the iPhone.

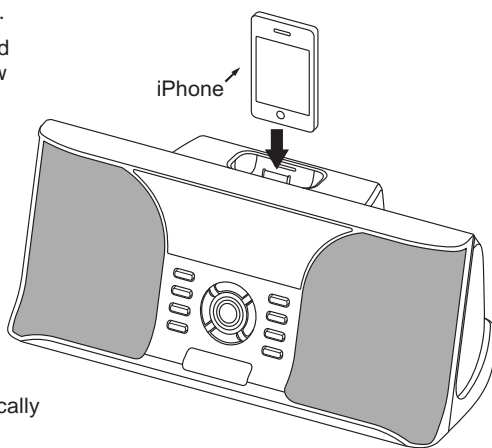

CONNECTING THE S-VIDEO (for iPod Video Output)

You are able to view videos and photos stored in your 5th generation iPod, iPod classic, 3rd generation iPod nano and iPod touch on a standard TV screen or video display using the S-Video OUT feature of this unit.

General Set Up

1. Connect one end of the S-Video cable into the rear S-Video OUT Jack on this unit and the other end to the VIDEO IN of your TV or video display.
2. Switch on your TV or video display.
3. Press the **FUNCTION** button to select iPod mode.
4. Securely dock the iPod and select Videos mode.
5. Select Video Settings on your iPod and set TV Out options to "On".
6. Return to the Videos Menu and select your favorite movie or video clips.
7. Press the Play Button to start playing.

iPod	
Music	>
Photos	>
Videos	>
Extras	>
Settings	>
Shuffle Songs	>

Videos	
Video Playlists	>
Movies	>
Music Videos	>
TV Shows	>
Video Podcasts	>
Video Setting	>

For Photo View (For iPod with color display ONLY – excluding iPod nano)

1. Press the **FUNCTION** Button to select iPod mode.
2. Securely dock the iPod with color display.
3. iPod: At TV Out section, make sure it is set to "ON".
4. iPod: Go to Photo Library and then press play. The slideshow will play on your device.

Settings	
TV Out	On
TV Signal	NTSC
Wide Screen	On

CONNECTING THE S-VIDEO (for iPhone Video Output)

You are able to view videos and photos stored in your iPhone on a standard TV or video display using the S-Video OUT feature of this unit.

For Video View (For iPhone with video ONLY)

You can connect this unit to a TV or other video display that has S-video input.

1. Connect the S-Video cable into the rear S-Video OUT Jack on the unit.
2. Connect the other end of the S-Video cable to the VIDEO IN of your TV or video display.
3. Press the FUNCTION button to select iPod mode.
4. Securely dock the iPhone with the iPhone in Video mode. Touch the Video Icon on the iPhone to enter Video mode if necessary.
5. Select a movie from your iPod menu.
6. To stop music playback, select your desired movie or video clip on the touch screen. The following screen will pop up in the iPhone Display.
7. To view the movie on your TV, touch "Yes".
8. Adjust **VOLUME +/-** for the desired sound level.

Display on TV?	
Yes	No

Note: When playing slideshows or videos on your TV, the audio will only playback through the JiMS-525i speakers.

USING HEADPHONES (NOT INCLUDED)

Inserting the plug of your headphones (not included) into the Headphone jack, on the back of the Radio, will enable you to listen in private. When using headphones, the speakers will be disconnected automatically.

NOTE: READ THIS IMPORTANT INFORMATION BEFORE USING YOUR HEADPHONES

1. Avoid extended play at very high volume as it may impair your hearing.
2. If you experience ringing in your ears, reduce the volume or shut off your unit.
3. Keep the volume at a reasonable level even if your headset is an open-air type designed to allow you to hear outside sounds. Please note that excessively high volume may still block outside sounds.

CLOCK SETTING

The following procedures can be accomplished by using either the remote or the controls on the main unit.

Setting the Time

The Clock can only be set in POWER off mode.

1. Press and hold the SET Button for 2 seconds and the Hour digits of the clock will flash.
2. Press the ► or ◀ Buttons until the correct Hour digits appear in the LCD.

Note: Make sure the hour is set so that AM or PM is correctly displayed. It is important that the "AM" or "PM" setting is correct for proper operation of the Alarm function.

3. Press the SET Button to confirm. Minute digits will appear and flash in the LCD.
4. Press the ► or ◀ Buttons to set the Minute digits.
5. Press the SET Button to exit and activate the new clock time to operate.

CLOCK SETTING (Continued)

Setting the Alarm (s)

- i. This Radio allows you to set two different wake-up times which can be used independently or simultaneously AL1 or AL2 or AL1 and AL2.
- ii. The procedure for setting the alarm time for ALARM 1 and ALARM 2 are the same.
- iii. The following procedure describes how to set ALARM 1 alarm time:

1. In POWER off mode, press the ALARM 1 Button briefly. The ALARM 1 Alarm Indicator  appears.
2. Press and hold the ALARM 1 Button until the wakeup sound source appears and flashes in the display.
3. Press the **▶▶** or **◀◀** Buttons repeatedly to select the Alarm1 wakeup mode (HD Radio FM, HD Radio AM, iPod or Buzzer).



4. Press the ALARM1 Button to confirm when the desired wakeup mode appears in the Display. The Display will then show the flashing Hour digits prompting for input.
5. Press the **▶▶** or **◀◀** Buttons to select the desired wakeup Hour.

Note: Make sure the hour is set so that AM or PM is correctly displayed. It is important that the "AM" or "PM" setting is correct for proper operation of the Alarm function.

6. Press the ALARM 1 Button again to confirm the wakeup Hour. Minute digits will appear and flash in the Display.
7. Press the **▶▶** or **◀◀** Buttons to select the desired Minutes.
8. Press the ALARM 1 Button again to confirm the Minutes. The Alarm sound level will then be displayed and flash to prompt for input.
9. Press the **VOLUME +** or **-** Buttons to select the desired wakeup sound level.
10. Press the ALARM 1 Button to confirm and the alarm setting process is then completed.

CLOCK LIGHT OPERATION

1. For a bright LCD Display under normal room illumination, press the SNOOZE/LIGHT Button once. The LCD backlight will turn on.
2. For a dim LCD Display in the dark press the SNOOZE/LIGHT Button again to turn the LCD backlight off.

ALARM OPERATION

This unit provides wake to HD Radio FM, HD Radio AM, iPod or ALARM.

Wake to Radio, iPod or Alarm

1. Refer to "SETTING THE ALARMS" on page 18 to set the desired wake up time (s), wakeup mode, i.e. HD RADIO FM, HD Radio AM, iPod or ALARM and volume level.

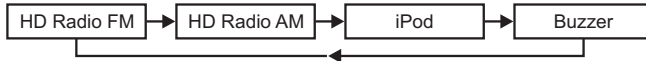

2. When the preset wake up time is reached the selected wakeup mode turns "On". The respective ALARM Indicator flashes. The alarm will continue to sound and last for 60 minutes and then turn off automatically. The alarm remains set and will turn the radio on again at the same time on the following day.
3. To stop the alarm sound before it turns off automatically, briefly press the **ALARM1** or **ALARM 2** Button once. The alarm sound stops but the alarm remain set and will turn the radio on again at the same time on the following day.
4. To cancel the alarm function briefly press the **ALARM1** and/or **ALARM 2** Buttons again. The respective ALARM indicator(s) goes off.

Notes:

- i. If you have chosen "Wake to RADIO" alarm mode, make sure that you have tuned to a station and adjusted the volume to a comfortable level.
HD Radio™ Multicast Channels (HD2, HD3, etc) cannot be used when "Wake to Radio" is selected. If the FM radio station you select for wake up is a Multicast Channel, the radio will turn on at the designated wake time, but the default main non-HD radio station will come on. Example: "97.9FM HD2" is selected before going to sleep. When the wake time is reached the radio will turn on to 97.9FM and not to the HD2 multicast channel. If an HD signal is detected, the station will automatically switch to the default 97.9FM HD1, but you will manually need to change to 97.9FM HD2 if this is the channel you want to listen to.
- ii. If "Wake to iPod" alarm mode is selected, make sure that there is an iPod in the Radio and the volume is set to a comfortable level.
- iii. In "Wake to iPod" alarm mode, the ALARM will sound if no iPod is inserted in the Radio.

SNOOZE OPERATION

1. When the alarm sounds (alarm, radio or iPod), you can press the SNOOZE/LIGHT Button to extend the alarm time by 9 minutes. The alarm, radio or iPod will then turn on again.
2. The SNOOZE operation can be repeated several times within the 60 minutes alarm duration.

SLEEP OPERATION

You can use the SLEEP Timer to fall asleep to Radio or iPod for a maximum duration of 90 minutes.

Setting Sleep Timer

Note: The default SLEEP duration is 90 minutes.

1. In Power On mode, operate the Radio or iPod as usual. Adjust the volume to the desired level.
2. Press the SLEEP Button. The Sleep Indicator ☹ appears in upper right corner of the Display. The display will show 90 minutes of playing time and then return to show the current time in a few seconds. The Sleep Indicator ☹ flashes in upper right corner of the Display.

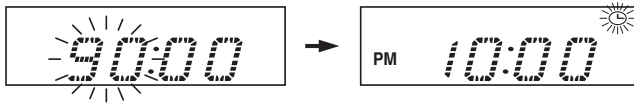

The Radio or iPod will automatically turn off after 90 minutes has elapsed. The SLEEP Indicator ☹ will disappear in the Display.

Adjusting the Sleep Period

1. With the unit In POWER ON mode, press the SLEEP Button. The display will show 60 minutes of playing time.
2. To adjust the sleep time for less than 90 minutes, press the ⏮ Button repeatedly. The sleep time will decrease in 5 minutes decrement every time the SLEEP Button is pressed. Stop pressing the ⏮ Button when your desired sleep time is displayed.
3. To adjust the sleep time for more than 5 minutes, press the ⏭ Button repeatedly. The sleep time will increase in 5 minutes increment every time the SLEEP Button is pressed. Stop pressing the ⏭ Button when the desired sleep time is displayed.
4. The unit will automatically turn off after the preset sleep time has elapsed. However, if you want to turn the radio off before the preset sleep time has elapsed, press the ⏻ Button once to switch the power off. The LCD Backlight turns off and the SLEEP Indicator ☹ disappears in the Display.

Note: Make sure the **FUNCTION** is set to the iPod or RADIO position before you press the **SLEEP** Button. No sound will be heard if the **FUNCTION** is set to the **ALARM** position.

SLEEP AND WAKE TO BUZZER/iPod/RADIO

1. Refer "SETTING THE ALARMS" in page 18 to set the desired wake up time (s), wakeup mode, i.e. RADIO, iPod or ALARM and volume level.
2. Follow step 1-3 (shown above) under the "ADJUSTING THE SLEEP PERIOD" section to set the desired SLEEP time.

The Radio is now programmed to turn off automatically at the Sleep Time you selected and then to turn on again at the preset "Alarm Time".

CARE AND MAINTENANCE

1. Avoid operating your unit under direct sunlight or in hot, humid or dusty places.
2. Keep your unit away from heating appliances and sources of electrical noise such as fluorescent lamps or motors.
3. For better Clock Display clarity, avoid operating the unit under direct sunlight or in strong room illumination.
4. Unplug the unit from the electrical power outlet immediately in case of malfunction.

Cleaning the Unit

- To prevent fire or shock hazard, disconnect your unit from the AC power source when cleaning.
- The finish on the unit may be cleaned with a dust cloth and cared for as other furniture, Use caution when cleaning and wiping the plastic parts.
- If the cabinet becomes dusty wipe it with a soft dry dust cloth. Do not use any wax or polish sprays on the cabinet.
- If the front panel becomes dirty or smudged with fingerprints it may be cleaned with a soft cloth slightly dampened with a mild soap and water solution. Never use abrasive cloths or polishes as these will damage the finish of your unit.

CAUTION: Never allow any water or other liquids to get inside the unit while cleaning.

SPECIFICATIONS

General

Power FUNCTION:	AC 120V ~ 60Hz 20W
Dimensions:	13.5 (L) x 6.6 (D) x 5.9 (H) Inch
Weight:	4.9 lb

Radio Frequency Coverage

AM:	530 – 1710 kHz
FM:	87.5 – 108 MHz
Speakers:	2 x 8 ohms
Output Power:	2 x 2.5W

HD Radio™ is a trademark of iBiquity Digital Corp. HD Radio™ Technology Manufactured Under License From iBiquity Digital Corporation. U.S. and Foreign Patents. HD Radio™ and the HD Radio logo are proprietary trademarks of iBiquity Digital Corp.

iPod is a trademark of Apple Inc., registered in the U.S. and other countries.

iPhone is a trademark of Apple Inc.

"Made for iPod" means that an electronic accessory has been designed to connect specifically to iPod and has been certified by the developer to meet Apple performance standards.

"Works With iPhone" means that an electronic accessory has been designed to connect specifically to iPhone and has been certified by the developer to meet Apple performance standards.

Apple is not responsible for the operation of this device or its compliance with safety and regulatory standards.

TROUBLESHOOTING GUIDE

If you experience difficulties in the use of this product, please check the following or call 1-800-777-5331 for Customer Service.

Symptom	Possible Cause	Solution
The unit does not respond. (no power)	AC cord is not plugged properly into a wall outlet or the connector is not plugged into the AC IN jack on the back of the unit. Wall outlet is not functioning.	Plug the AC cord into a wall outlet and plug the connector into the AC IN jack on the unit. Plug another device into the same out outlet to confirm the outlet is working.
iPod does not install properly.	Using no/wrong iPod Adaptor. iPod does not dock properly.	Make sure the dock insert is properly fit for your iPod. Remove your iPod from the dock and check for obstruction on the connectors in the dock and on your iPod. Then reseal it in the dock.
iPod does not respond to the system.	iPod is not installed properly. Your iPod is locked up.	Remove your iPod from the dock and check for obstruction on the connectors in the dock and on your iPod. Then reseal it on the dock. Please make sure your iPod is working properly before docking into the unit. Please refer to your iPod manual for info on resetting the iPod.
iPod does not charge up.	iPod is not installed properly. iPod is locked up/ frozen. iPod battery has problem.	Remove your iPod from the dock and check for obstruction on the connectors in the dock and on your iPod. Then reseal it in the dock. Please make sure your iPod is working properly before docking into the unit. Please refer to your iPod manual for details on resetting.
AM band is too noisy.	The reception at the set location is poor.	Slightly rotate the AM loop antenna position for the best reception. Move the AM loop antenna away from the unit to avoid interference.
FM band is too noisy.	The reception at the set location is poor.	Check that if the plug of the FM antenna wire connects properly with the FM antenna terminal at the rear of the unit. Straighten the FM antenna wire away from the unit and stretch out the end point of the antenna wire into "T" shape and placed the "T" shape antenna rear the window for better reception.

SERVICE

Please refer to the instructions on the enclosed warranty card for returning your unit for service. When returning the unit, please remove any batteries to prevent damage to the unit in transit and/or from possible battery leakage. We are not responsible for batteries returned with the product or for the cost of replacement.

Distributed by:

Spectra Merchandising International, Inc.

Chicago Industry Tech Park

4230 North Normandy Avenue

Chicago, IL 60634, U.S.A.

Please have model number ready, for Customer Service, call 1-800-777-5331