



Portable Stereo Bluetooth Music System with CD



USER MANUAL CD-565



PLEASE READ THIS USER MANUAL COMPLETELY BEFORE OPERATING
THIS UNIT AND RETAIN THIS BOOKLET FOR FUTURE REFERENCE.

WARNING

TO PREVENT FIRE OR SHOCK HAZARD, DO NOT USE THIS PLUG WITH AN EXTENSION CORD, RECEPTACLE OR OTHER OUTLET UNLESS THE BLADES CAN BE FULLY INSERTED TO PREVENT BLADE EXPOSURE. TO PREVENT FIRE OR SHOCK HAZARD, DO NOT EXPOSE THIS APPLIANCE TO RAIN OR MOISTURE.

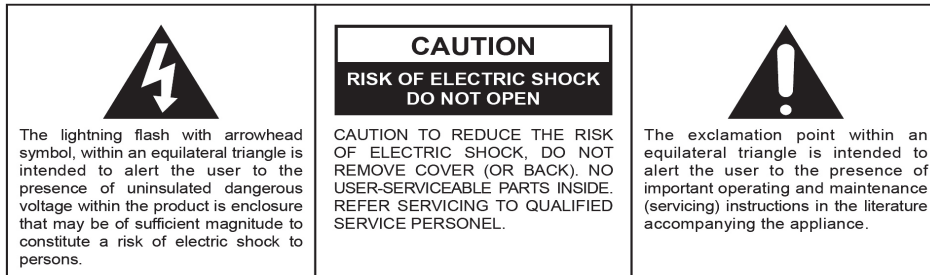

The Caution Marking is located at the bottom enclosure of the apparatus.
The Rating plate is located at the bottom enclosure of the apparatus

IMPORTANT SAFETY INSTRUCTIONS

1. Read these instructions.
2. Keep these instructions.
3. Heed all warnings.
4. Follow all instructions.
5. Do not use this apparatus near water.
6. Clean only with dry cloth.
7. Do not block any ventilation openings. Install in accordance with the manufacturer's instructions.
8. Do not install near any heat sources such as radiators, heat registers, stoves, or other apparatus (including amplifiers) that product heat.
9. Do not defeat the safety purpose of the polarized or grounding-type plug. A polarized plug has two blades with one wider than the other. A grounding type plug has two blades and a third grounding prong. The wide blade or the third prong is provided for your safety. If the provided plug does not fit into your outlet, consult an electrician for replacement of the obsolete outlet.
10. Protect the power cord from being walked on or pinched particularly at plugs, convenience receptacles, and the point where they exit from the apparatus.
11. Only use attachments/accessories specified by the manufacturer.
12. Use only with a cart, stand, tripod, bracket, or table recommended by the manufacturer, or sold with the product. When a cart is used, use caution when moving the cart/apparatus combination to avoid injury from tip-over.
13. Unplug this apparatus during lightning storms or when unused for a long period of time.
14. Refer all servicing to qualified service personnel. Servicing is required when the apparatus has been damaged in any way, such as power-supply cord or plug is damaged, liquid has been spilled or objects have fallen into the apparatus, the apparatus has been exposed to rain or moisture, does not operate normally, or has been dropped.



15. This appliance shall not be exposed to dripping or splashing water and that no object filled with liquids such as vases shall be placed on the apparatus.
16. Do not overload wall outlet. Use only power source as indicated.
17. Use replacement part as specified by the manufacturer.
18. Upon completion of any service or repairs to this product, ask the service technician to perform safety checks.
19. Power Sources - This product should be operated only from the type of power source indicated on the marking label. If you are not sure of the type of power supply to your home, consult your product dealer or local power company. For products intended to operate from battery power, or other sources, refer to the operating instruction.
20. Object and Liquid Entry - Never push objects of any kind into this product through openings as they may touch dangerous voltage points or short-out parts that could result in a fire or electric shock. Never spill liquid of any kind on the product.
21. Damage Requiring Service - Unplug this product from the wall outlet and refer servicing to qualified service personnel under the following conditions:
 - a) When the power-supply cord or plug is damaged,
 - b) If liquid has been spilled, or objects have fallen into the product,
 - c) If the product has been exposed to rain or water,
 - d) If the product does not operate normally by following the operating instructions. Adjust only those controls that are covered by the operating instructions as an improper adjustment of other controls may result in damage and will often require extensive work by a qualified technician to restore the product to its normal operation.
 - e) If the product has been dropped or damaged in any way, and
 - f) When the product exhibits a distinct change in performance - this indicates a need for service.
22. Mains plug is used as disconnect device and it should remain readily operable during intended use. In order to disconnect the apparatus from the mains completely, the mains plug should be disconnected from the mains socket outlet completely.
23. Battery shall not be exposed to excessive heat such as sunshine, fire or the like.
24. Excessive sound pressure from earphones and headphone can cause hearing loss.
25. Minimum distances of 4 inches around the apparatus for sufficient ventilation.
26. The ventilation should not be impeded by covering the ventilation openings with items, such as newspapers, table-cloths, curtains, etc.
27. No naked flame sources, such as lighted candles, should be placed on the apparatus.
28. The use of apparatus in moderate climates.
29. Attention should be drawn to the environmental aspects of battery disposal.

This symbol indicates that this product incorporates double insulation between hazardous mains voltage and user accessible parts.



SAVE THESE INSTRUCTIONS

COMPLIANCE WITH FCC REGULATIONS

FCC ID: 2ASQA6961448

This device complies with Part 15 of the FCC Rules. Operation is subject to the following two conditions:

- (1) This device may not cause harmful interference, and
- (2) This device must accept any interference received, including interference that may cause undesired operation.

This equipment has been tested and found to comply with the limits for a Class B Digital Device, pursuant to Part 15 of the FCC Rules. These limits are designed to provide reasonable protection against harmful interference in a residential installation. This equipment generates, uses and can radiate radio frequency energy and, if not installed and used in accordance with the instructions, may cause harmful interference to radio communications. However, there is no guarantee that interference will not occur in a particular installation. If this equipment does cause harmful interference to radio or television reception, which can be determined by turning the equipment off and on, the user is encouraged to try to correct the interference by one or more of the following measures:

- Reorient or relocate the receiving antenna.
- Increase the separation between the equipment and receiver.
- Connect the equipment into an outlet on a circuit different from that to which the receiver is connected.
- Consult the dealer or an experienced radio/TV technician for help.

WARNING

Changes or modifications to this unit not expressly approved by the party responsible for compliance could void the user's authority to operate the equipment.

CAUTION

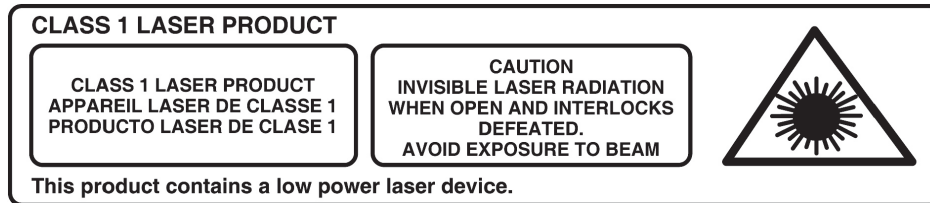

Follow the advice below for safe operations.

ON PROTECTION AGAINST LASER ENERGY EXPOSURE

- As the laser beam used in this compact disc player is harmful to the eyes, do not attempt to disassemble the casing.
- Stop operation immediately if any liquid or solid object should fall into the cabinet.
- Do not touch the lens or poke at it. If you do, you may damage the lens and the player may not operate properly.

- Do not put anything in the safety slot. If you do, the laser diode will be ON when the CD door is still open.
- If the unit is not to be used for a long period of time, make sure that all power sources are disconnected from the unit. Remove all batteries from the battery compartment.
- This unit employs a laser. The use of controls or adjustment or performance of procedures other than those specified here may result in exposure to hazardous radiation.

ON CONDENSATION

- When left in a heated room where it is warm and damp, water droplets or condensation may form inside the unit.
- When there is condensation inside the unit, the unit may not function normally. Let it stand for 1 to 2 hours before turning the power on, or gradually heat the room up and dry the unit before use.

Should any trouble occur, disconnect the AC Adapter and refer servicing to qualified personnel.

PROTECT YOUR FURNITURE

This system is equipped with non-skid rubber 'feet' to prevent the product from moving when you operate the controls. These 'feet' are made from non-migrating rubber material specially formulated to avoid leaving any marks or stains on your furniture. However certain types of oil based furniture polishes, wood preservatives, or cleaning sprays may cause the rubber 'feet' to soften, and leave marks or a rubber residue on the furniture.

To prevent any damage to your furniture we strongly recommend that you purchase small self-adhesive felt pads, available at hardware stores and home improvement centers everywhere and apply these pads to the bottom of the rubber 'feet' before you place the product on fine wooden furniture.

DEAR JENSEN® CUSTOMER

Selecting fine audio equipment such as the unit you've just purchased is only the start of your musical enjoyment. Now it's time to consider how you can maximize the fun and excitement your equipment offers. This manufacturer and the Electronic Industries Association's Consumer Electronics Group want you to get the most out of your equipment by playing it at a safe level. One that lets the sound come through loud and clear without annoying blaring or distortion and, most importantly, without affecting your sensitive hearing. Sound can be deceiving. Over time your hearing "comfort level" adapts to higher volumes of sound. So what sounds "normal" can actually be loud and harmful to your hearing. Guard against this by setting your equipment at a safe level BEFORE your hearing adapts.

To establish a safe level:

- Start your volume control at a low setting.
- Slowly increase the sound until you can hear it comfortably and clearly, and without distortion.

Once you have established a comfortable sound level:

- Set the dial and leave it there.

Taking a minute to do this now will help to prevent hearing damage or loss in the future. After all, we want you listening for a lifetime.

We Want You Listening For a Lifetime

Used wisely, your new sound equipment will provide a lifetime of fun and enjoyment. Since hearing damage from loud noise is often undetectable until it is too late, this manufacturer and the Electronic Industries Association's Consumer Electronics Group recommend you avoid prolonged exposure to excessive noise.



Customer's Record:

The serial number of this product is found on its bottom cover. You should note the serial number of this unit in the space provided as a permanent record of your purchase to aid in identification in the event of theft or loss.

Model Number: CD-565

Serial Number: _____

LOCATION OF CONTROLS

Top View

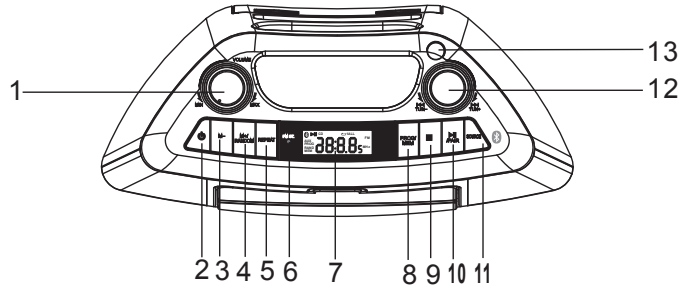



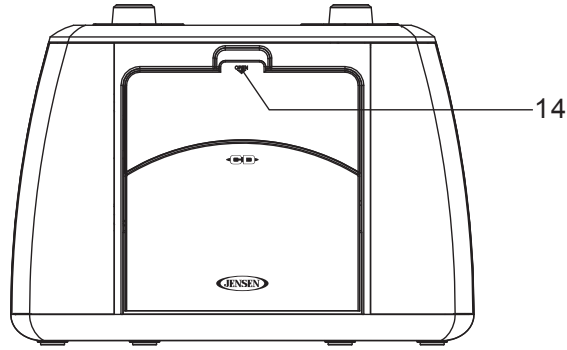

Front View

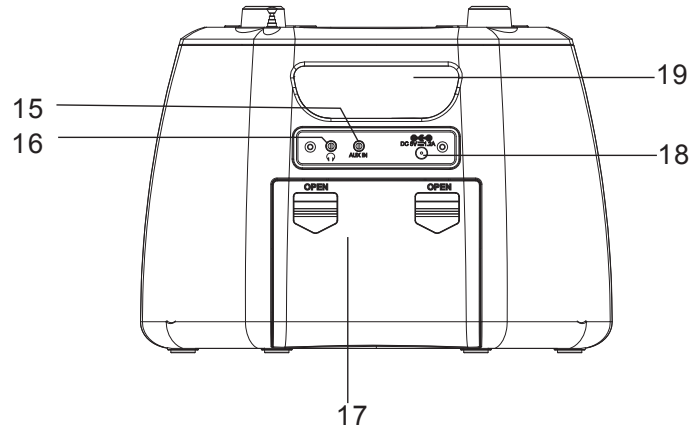

Rear View



1	VOLUME CONTROL	11	SOURCE BUTTON
2	POWER  BUTTON	12	TUNING CONTROL KNOB
3	MEMORY- BUTTON	13	TELESCOPIC ANTENNA
4	MEMORY+ / RANDOM PLAY BUTTON	14	CD DOOR OPEN
5	REPEAT  BUTTON	15	AUX IN JACK
6	FM STEREO INDICATOR	16	HEADPHONE JACK
7	LCD DISPLAY	17	BATTERY DOOR
8	PROGRAM/MEMORY BUTTON	18	DC IN JACK
9	STOP  BUTTON	19	BUILT-IN HANDLE
10	PLAY/PAUSE  / PAIR BUTTON		

POWER SOURCE

This unit operates using the included AC Adaptor or using 6 x 1.5VDC "C" (UM-2) batteries (not included). Do not attempt to operate the unit on any other power source. You could cause damage to the unit and void your warranty. Please be sure the power outlet you plug this unit into is working and receives constant (unswitched) power.

AC OPERATION

An AC Adaptor with 5V DC, 1000 mA output voltage is included and is required for operating this in AC power mode"

1. Securely insert the DC plug of the adaptor cord into the DC Jack located on the back of the unit.
2. Plug the AC Adaptor into a 120V AC wall outlet.
3. Connecting this unit to any other power source may cause damage to the unit.
4. Press the POWER  button located on the top of the unit to turn the unit ON.
5. The LCD display will light.

Note: Unplug the AC adaptor from the unit and the wall outlet if you're not going to be using it for an extended period of time.

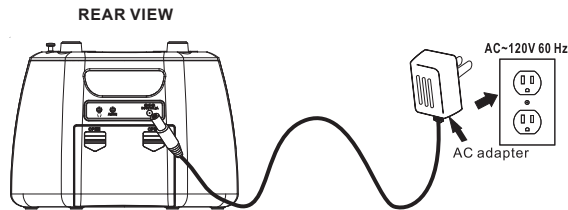

BATTERY OPERATION

Unplug the AC adaptor from the wall and from the unit prior to installing the batteries (not included).

1. Remove the battery door located on the back of the unit.
2. Following the polarity diagram located inside the battery compartment, install the 6 x 1.5VDC "C" (UM-2) batteries (not included).

Note: For best performance, alkaline-type batteries are recommended.

3. Reattach the battery door and make sure it's securely locked in place.

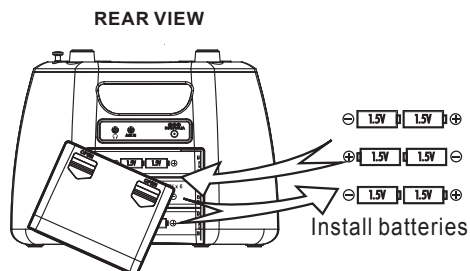

IMPORTANT: Be sure that the batteries are installed correctly. Wrong polarity may damage the unit and void the warranty.

SWITCHING FROM BATTERY OPERATION TO AC OPERATION

Insert the DC plug of the AC adaptor cord into the DC Jack located on the back of the unit. The batteries will automatically be disconnected once the plug is inserted. Plug the AC Adaptor into a 120V AC wall outlet.

NOTE: To avoid losing any preset radio stations saved in memory, it's important that you plug the AC Adaptor into a 120V AC wall outlet within 30 seconds from the time the DC plug is inserted into the CD-565.





⚠ BATTERY NOTE AND CARE

1. Danger of explosion if the battery is replaced incorrectly. Replace only with the same or equivalent type
2. Do not mix old and new batteries.
3. Do not mix alkaline, standard (carbon-zinc) or rechargeable (nickel-cadmium) batteries.
4. If the unit is not to be used for an extended period of time, remove the batteries. Old or leaking batteries can cause damage to the unit and may void the warranty.
5. Do not try to recharge batteries not intended to be recharged; they can overheat and rupture. (Follow battery manufacturer's directions).
6. Do not dispose of batteries in fire, batteries may leak or explode.

BATTERY REPLACEMENT

When the output sound of this unit becomes distorted or the CD player operation appears unstable, the batteries are weak. You need to replace all the exhausted batteries at the same time as soon as possible to avoid battery leakage.

RADIO OPERATION

1. Press the **POWER**  button to turn the unit ON. The LCD display will light.
2. The unit defaults to FM radio mode when you power the unit up for the first time. If not, press the **SOURCE** button repeatedly to select FM mode.
3. The "FM" indicator and frequency will show on the LCD display.
4. To tune the radio manually, slightly rotate the TUNING CONTROL KNOB counterclockwise (TUN- ) or clockwise (TUN+ ) until you hear a "click" sound.
5. Rotate the TUNING CONTROL KNOB counterclockwise (TUN- ) to go DOWN in frequency, and clockwise (TUN+ ) to go UP in frequency.
6. Rotate and hold the TUNING CONTROL KNOB counterclockwise to search DOWN to the next lower station available, or clockwise to search UP to the next available station.
7. Adjust the **VOLUME CONTROL** to obtain the desired sound level.

TIPS FOR BEST RADIO RECEPTION

- If a stereo broadcast program is being received, the FM STEREO INDICATOR will automatically light.
- Always keep the FM TELESCOPIC ANTENNA fully extended for best performance.
- If the FM reception is weak, try rotating the antenna or reposition the unit closer to a window until the reception improves.

SETTING THE RADIO STATION PRESETS

The unit allows you to store up to **20 FM stations** for easy recall at any time.

1. Press the **SOURCE** button repeatedly to select FM radio mode. The “**FM**” indicator and frequency will show on the LCD display.
2. Tune to the radio station you want to store in memory.
3. Tap the **PROG/MEM** button. The preset channel number “P01” will begin flashing for 10 seconds on the LCD DISPLAY.
4. Tap the **M-** button or **M+ / RANDOM** button to select the preset location (P01 – P20).
5. Tap the **PROG/MEM** button to confirm.
6. Repeat steps 2 - 5 above to fill the remaining 19 memory locations if needed.

RECALLING THE PRESET RADIO STATIONS









In FM mode, tap the **M-** button or **M+ / RANDOM** button to select the preset channel.

CD OPERATION

PLEASE READ THIS IMPORTANT INFORMATION:

CD mechanisms used in devices like this are designed to fully read all commercial CDs. They will also read self-compiled CD-R/CD-RW discs but it may take up to 10 seconds for playback to start. If playback does not start, it is likely due to the quality of the CD-R/RW disc and/or the compatibility of the CD compilation software. Manufacturer is not responsible for the playback quality of CD-R/RW discs.

Do not attach a label or seal to either side of the CD-R/RW disc. It may cause a malfunction.

1. Press the **POWER**  button to turn on the unit power.
2. Press the **SOURCE** button repeatedly to select CD mode. The “CD” indicator will light and the display will show “- - -” briefly on the display.
3. If no CD is loaded in the CD compartment, the LCD display will change to show “No”.
4. Open the CD door and carefully place an audio CD onto the spindle in the CD compartment and close the CD door. Make sure the CD label is facing outwards.
5. The player will start reading the TOC (table of contents) of the disc, and the total number of tracks on the CD will appear on the LCD DISPLAY after a few seconds.
6. Tap the **PLAY/PAUSE**  / **PAIR** button to start to playing the CD.
7. Adjust the **VOLUME CONTROL** to obtain the desired sound.
8. To pause, tap the **PLAY/PAUSE**  / **PAIR** button. To resume playing, tap the **PLAY/PAUSE**  / **PAIR** button again.
9. To select a specific track on the CD, slightly rotate the **TUNING CONTROL KNOB** counterclockwise (**TUN-** ) or clockwise (**TUN+** ) until you hear a “click” sound.
10. Rotate the **TUNING CONTROL KNOB** counterclockwise (**TUN-** ) to go DOWN a track, or clockwise (**TUN+** ) to go UP a track. The LCD Display will indicate the track selected.
11. To locate a particular section of a song within a track playing, rotate and hold the **TUNING CONTROL KNOB** counterclockwise to search BACK within the track playing, or clockwise to search FORWARD within the track playing.

12. To repeat a particular track, tap the **REPEAT** button once, the Repeat 1 indicator “↺” lights on the LCD DISPLAY.
13. To repeat the entire CD, tap the **REPEAT** button twice, the Repeat all indicator “↺ALL” lights on the LCD DISPLAY.
14. To cancel Repeat Function, tap the **REPEAT** button until REPEAT indicator goes off from LCD display.
15. To shuffle play the entire CD, tap the **M+/RANDOM** button, the random play indicator “RAND” lights on the LCD DISPLAY. Tap the **RANDOM** button again to cancel the shuffle play if necessary.
16. To stop playing, tap the STOP ■ button.
17. Tap the ⏻ Button to turn the unit OFF.

PROGRAM OPERATION

This function allows the tracks to be played in a programmed sequence. Programs can be set in STOP mode.

1. Tap the **PROG/MEM** button once. The “PROG” Indicator will flash and program Channel Number “P01” will show briefly and then “00” flashing on the LCD DISPLAY.
2. Slightly rotate the TUNING CONTROL KNOB counterclockwise (TUN-◀◀) or clockwise (TUN+▶▶) until you hear a “click” sound.
3. Rotate the TUNING CONTROL KNOB counterclockwise (TUN-◀◀) to go DOWN a track, or clockwise (TUN+▶▶) to go UP a track. The LCD Display will indicate the track selected to be programmed.
4. Tap the **PROG/MEM** button again to store selection. The program Channel Number will change to “P02” briefly on the LCD DISPLAY and then “00” flashing to prompt for input next program track.
5. Repeat steps 2 - 3 to program as many as 20 tracks.
6. Tap the PLAY/PAUSE ▶|| button to start the programmed play.
7. You may tap the **REPEAT** button repeatedly to select repeat 1 or all programmed tracks.
8. Tap STOP ■ button once to stop playback.
9. Tap the PLAY/PAUSE ▶|| button to resume programmed play.
10. To cancel programmed play, press the STOP ■ button twice.

BLUETOOTH OPERATION

PAIRING A SMARTPHONE OR BLUETOOTH ENABLED DEVICE

The Bluetooth feature enables you to stream and play the digital music on your Bluetooth enabled device to your unit.

1. With the power ON, tap the **SOURCE** button repeatedly to select Bluetooth mode. The Bluetooth ℹ indicator will light and “bt” will be flashing on the LCD display.
2. The unit will go into auto connection mode and search for a previously paired device that is still active and in range (30 feet/10 meters). If found, a brief welcome melody will be heard and “bt” indicator will stop flashing and remain on. If no active Bluetooth device is found, the unit will switch to interactive pairing mode and the “bt” indicator will continue flashing.
3. To establish a new link, turn on the Bluetooth function of your Bluetooth enabled device and enable the search or scan feature to find “CD-565” in the list of discoverable Bluetooth devices. Select the “CD-565” from your available device list when it appears on its screen and a brief welcome melody will be heard if pairing and connection is successful. If you are asked for a password, enter “0000”.

4. After successfully pairing and connecting your device with CD-565, the unit will emit a brief welcome melody and the Bluetooth indicator will change to solid on. You can now play music from your Bluetooth enabled device wirelessly to the CD-565.
5. If you want to connect the CD-565 to another new external Bluetooth enabled device while paired with another device, press and hold the **▶||/PAIR** button for few seconds to disconnect the existing connection. The unit will emit two short beeps and Bluetooth connection indicator "bt" will change to flash. Repeat steps #3 to #4 above to make a new link.
6. Rotate the VOLUME CONTROL on the top panel to increase the listening volume gradually until a comfortable listening level is reached.
7. Press the PLAY/PAUSE **▶||** button to control play/pause.
8. Slightly rotate the TUNING CONTROL KNOB counterclockwise (TUN- **◀◀**) or clockwise (TUN+ **▶▶**) until you hear a "click" sound.
9. Rotate the TUNING CONTROL KNOB counterclockwise (TUN- **◀◀**) to go BACK a song, or clockwise (TUN+ **▶▶**) to go FORWARD to the next song.

Notes:

- If you cannot pair the unit with your Bluetooth enabled device, try solving the problem by turning the unit power off, then power on, and then starting the pairing process again.
- The Bluetooth function of the unit will remain paired unless the paired device goes out of range of 30 feet (10 meters). If the broken link is re-established within 10 minutes, the CD-565 will reconnect to the current paired device automatically. Otherwise you will need to make a manual connection again later.
- You may need to turn off the Bluetooth function of the paired external device first before making a new link.
- Refer to manual of your smartphone or external Bluetooth enabled device for correct Bluetooth operation instructions since it may vary from model to model.
- If your Bluetooth enabled device does not support A2DP, it will not play the music through the CD-565 system even after it is paired and connected successfully.
- If you are pairing and connecting your personal computer to the CD-565 using Bluetooth, you may need to set the CD-565 as your computer's default sound device.

RE-LINKING TO A SMARTPHONE OR BLUETOOTH ENABLED DEVICE

Even if your smartphone or Bluetooth device is already paired with the CD-565 and with both Bluetooth functions turned on, they can become unlinked at some point due to intentional manual disconnection or undesirable external signal interferences or over-range for more than 3 seconds. If this happens, the unit will emit two short beeps. You can re-link them and resume play by:

1. Select "CD-565" from the device list on your smartphone or Bluetooth device. The CD-565 should re-link to your Bluetooth enabled device within 5 seconds.
2. Tap the play button of the music player on your Bluetooth enabled device to resume playback.

AUX IN OPERATION

You can play other music sources (iPod, MP3 or other digital audio players) through the speakers of the unit by connecting the AUX IN JACK to your external player's audio out jack or headphone jack.

1. Plug one end of an audio cable (not included) into the AUX IN JACK and the other end of the cable to the headphone jack of your digital audio player.

2. Tap the **SOURCE** button repeatedly to select AUX mode.
3. AUX indicator and "AUH" will show on the LCD DISPLAY.
4. Turn on and start playing the external device you plugged into the AUX IN JACK.
5. Slowly adjust both the volume controls of your unit and the external device until you reach a comfortable listening level.

Notes:

- If you connect the unit to the Line-Out Jack of your external device, you only need to adjust the VOLUME CONTROL of your unit. If you connect to the Headphone Jack of your external device, you may need to adjust both the volume controls of your external device and the unit to obtain the desirable listening level.
- Remember to turn off the unit when you have finished listening. Don't forget to switch off the power of your external audio device as well.

USE HEADPHONES (NOT INCLUDED)

Connect the plug of the stereo headphone (not included) into the HEADPHONE JACK .

CAUTION

- Avoid excessive volume levels for long period of time when using the headphones. Prolonged use at high levels may impair your hearing.
- Do not use earphones while operating a motorized vehicle, as it may create a traffic hazard and is illegal in many areas

RESETTING THE UNIT

In case of malfunction due to electrostatic discharge, reset the unit by unplug the DC IN power jack from the back of the unit and also remove all the batteries from the battery compartment. Wait for 3 minutes before reconnecting the power and turning the unit back on.

CARE AND MAINTENANCE

1. Do not subject the unit to excessive force, shock, dust or extreme temperature.
2. Do not tamper the internal components of the unit.
3. Clean your unit with a dry cloth. Solvent or detergent should never be used.
4. Avoid leaving your unit in direct sunlight or in hot, humid or dusty places.
5. Keep your unit away from heating appliances and sources of electrical noise such as fluorescent lamps or motors.
6. If drop-outs or interruptions occur in the music during CD play, or if the CD fails to play at all, its bottom surface may require cleaning. Before playing, wipe the disc from the center outwards with a good soft cleaning cloth.



CLEANING THE UNIT

- To prevent fire or shock hazard, disconnect your unit from the AC power source when cleaning.
- The finish on the unit may be cleaned with a dust cloth and cared for as other furniture, Use caution when cleaning and wiping the plastic parts.
- If the cabinet becomes dusty wipe it with a soft dry dust cloth. Do not use any wax or polish sprays on the cabinet.
- If the front panel becomes dirty or smudged with fingerprints it may be cleaned with a soft cloth slightly dampened with a mild soap and water solution. Never use abrasive cloths or polishes as these will damage the finish of your unit.

CAUTION: Never allow any water or other liquids to get inside the unit while cleaning.

TROUBLE SHOOTING GUIDE

If you experience difficulties in the use of this unit, please check the following or call 1-800-777-5331 for Customer Service and support.

Symptom	Possible Cause	Solution
Noise or sound distorted on FM broadcast	Station not tuned properly for FM.	Fine tune the FM broadcast station.
	Telescopic antenna is not fully extended.	Fully extend the FM Telescopic antenna.
FM no sound	Unit not in Radio mode.	Press the SOURCE button repeatedly until to RADIO mode.
	Volume at minimum	Increase Volume level.
Bluetooth No Sound	Unit is not linked with your Bluetooth enabled device	Go through "Bluetooth Operations" process to link the speakers.
	Unit placement out of range.	Relocate the unit within Bluetooth operating range (30 feet) from the unit.
	Your Bluetooth enabled device Volume set too low.	Increase Volume level of your Bluetooth enabled device.
CD player will not play	Unit not in CD function mode.	Press the SOURCE button repeatedly until to CD mode.
	CD is installed incorrectly.	Insert CD with label side outward.
	If the CD is self-compiled, the media used may not be compatible with the player.	Use better quality blank media and retest.
CD skips while playing	Disc is dirty or scratched.	Wipe CD with clean cloth or use another disc.
Intermittent sound from CD Player	Dirty or defective disc.	Clean or replace the defective disc.
	Dirty pick up lens.	Use a CD-lens cleaning disc to clean the lens.
	Player is subject to excessive shock or vibration	Relocate the player away from shock or vibration

SPECIFICATION

Power requirement:

AC adaptor for main unit

AC input: 120V ~ 60Hz

DC output: 5V \equiv 1000 mA

Battery:

6 x "C"(UM-2) batteries (not included)

Frequency Range

Radio Band:

FM 87.5 ~ 108 MHz



At Spectra, environmental and social responsibility is a core value of our business. We are dedicated to continuous implementation of responsible initiatives with an aim to conserve and maintain the environment through responsible recycling.

Please visit us at <http://www.spectraintl.com/green.htm> for more information on Spectra's green initiatives or to find a recycler in your area.

The *Bluetooth*® word mark and logos are registered trademarks owned by Bluetooth SIG, Inc. and any use of such marks by Spectra Merchandising Intl, Inc. is under license. Other trademarks and trade names are those of their respective owners.

90 DAY LIMITED WARRANTY AND SERVICE VALID IN THE U.S.A. ONLY

SPECTRA MERCHANDISING INTERNATIONAL, INC. warrants this unit to be free from defective materials or factory workmanship for a period of 90 days from the date of original customer purchase and provided the product is utilized within the U.S.A. This warranty is not assignable or transferable. Our obligation under this warranty is the repair or replacement of the defective unit or any part thereof, except batteries, when it is returned to the SPECTRA Service Department, accompanied by proof of the date of original consumer purchase, such as a duplicate copy of a sales receipt.

You must pay all shipping charges required to ship the product to SPECTRA for warranty service. If the product is repaired or replaced under warranty, the return charges will be at SPECTRA's expense. There are no other express warranties other than those stated herein.

This warranty is valid only in accordance with the conditions set forth below:

1. The warranty applies to the SPECTRA product only while:
 - a. It remains in the possession of the original purchaser and proof of purchase is demonstrated.
 - b. It has not been subjected to accident, misuse, abuse, improper service, usage outside the descriptions and warnings covered within the user manual or non-SPECTRA approved modifications.
 - c. Claims are made within the warranty period.
2. This warranty does not cover damage or equipment failure caused by electrical wiring not in compliance with electrical codes or SPECTRA user manual specifications, or failure to provide reasonable care and necessary maintenance as outlined in the user manual.
3. Warranty of all SPECTRA products applies to residential use only and is void when products are used in a nonresidential environment or installed outside the United States.

This warranty gives you specific legal rights, and you may also have other rights which vary from state to state. TO OBTAIN SERVICE please remove all batteries (if any) and pack the unit carefully and send it freight prepaid to SPECTRA at the address shown below. IF THE UNIT IS RETURNED WITHIN THE WARRANTY PERIOD shown above, please include a proof of purchase (dated cash

register receipt) so that we may establish your eligibility for warranty service and repair of the unit without cost. Also include a note with a description explaining how the unit is defective. A customer service representative may need to contact you regarding the status of your repair, so please include your name, address, phone number and email address to expedite the process.

IF THE UNIT IS OUTSIDE THE WARRANTY PERIOD, please include a check for **\$25.00** to cover the cost of repair, handling and return postage. All out of warranty returns must be sent prepaid.

It is recommended that you contact SPECTRA first at 1-800-777-5331 or by email at custserv@spectraintl.com for updated information on the unit requiring service. In some cases the model you have may be discontinued, and SPECTRA reserves the right to offer alternative options for repair or replacement.

SPECTRA MERCHANDISING INTERNATIONAL, INC.
4230 North Normandy Avenue,
Chicago, IL60634, USA.
1-800-777-5331

To register your product, visit the link on the website below to enter your information.
<http://www.spectraintl.com/wform.htm>

0519

Printed in China