

BLUETOOTH CD MUSIC SYSTEM WITH DIGITAL FM STEREO RECEIVER AND REMOTE CONTROL



MODEL: JBS-500
USER MANUAL





**PLEASE READ THIS USER MANUAL COMPLETELY BEFORE OPERATING
THIS UNIT AND RETAIN THIS BOOKLET FOR FUTURE REFERENCE.**

Limited Edition Model

WARNINGS

TO PREVENT FIRE OR SHOCK HAZARD, DO NOT USE THE PLUG WITH AN EXTENSION CORD, RECEPTACLE OR OTHER OUTLET UNLESS THE BLADES CAN BE FULLY INSERTED TO PREVENT BLADE EXPOSURE. TO PREVENT FIRE OR SHOCK HAZARD, DO NOT EXPOSE THIS APPLIANCE TO RAIN OR MOISTURE.

 <p>The lightning flash and arrowhead within the triangle is a warning sign alerting you of "dangerous voltage" inside the product.</p>	<p style="text-align: center;">CAUTION RISK OF ELECTRIC SHOCK DO NOT OPEN</p> <p>CAUTION: TO REDUCE THE RISK OF ELECTRIC SHOCK DO NOT REMOVE COVER (ON BACK), NO USER SERVICEABLE PARTS INSIDE. REFER SERVICING TO QUALIFIED SERVICE PERSONNEL.</p>	 <p>The exclamation point within the triangle is a warning sign alerting you of important instructions accompanying the product.</p>
--	--	---

The Caution Marking is located at the back enclosure of the apparatus.
The Rating plate is located at the back enclosure of the apparatus.

IMPORTANT SAFETY INSTRUCTIONS

1. Read these Instructions.
2. Keep these Instructions.
3. Heed all Warnings.
4. Follow all Instructions.
5. Do not use this apparatus near water.
6. Cleaning-Unplug this product from the wall outlet before cleaning. Do not use liquid cleaners or aerosol cleaners. Clean only with dry cloth.
7. Do not block any ventilation openings. Install in accordance with the manufacturer's instructions.
8. Do not place this product on an unstable cart, stand, tripod, bracket, or table. The product may fail, causing serious injury to a child or adult, and serious damage to the product. Use only with a cart, stand, tripod, bracket, or table recommended by the manufacturer, or sold with the product. Any mounting of the product should follow the manufacturer's instructions and should use a mounting accessory recommended by the manufacturer. A product and cart combination should be moved with care-quick stops, excessive force and uneven surfaces may cause the product and cart combination to overturn.
9. Do not install near any heat sources such as radiators, heat registers, stoves, or other apparatus (including amplifiers) that produce heat.
10. Do not defeat the safety purpose of the polarized or grounding-type plug. A polarized plug has two blades with one wider than the other. A grounding type plug has two blades and a third grounding prong. The wide blade or the third prong are provided for your safety. When the provided plug does not fit into your outlet, consult an electrician for replacement of the obsolete outlet.

PORTABLE CART WARNING
(symbol provided by RETAC)



810-0000S-190

11. Protect the power adaptor from being walked on or pinched particularly at plugs, convenience receptacles, and the point where they exit from the apparatus.
12. Only use attachments/accessories specified by the manufacturer.
13. Unplug this apparatus during lightning storms or when unused for long periods of time.
14. Refer all servicing to qualified service personnel. Servicing is required when the apparatus has been damaged in any way, such as power-supply adaptor or plug is damaged, liquid has been spilled or objects have fallen into the apparatus, the apparatus has been exposed to rain or moisture, does not operate normally, or has been dropped.
15. This apparatus shall not be exposed to dripping or splashing and that no objects filled with liquids, such as vases, shall be placed on apparatus.
16. Do not overload wall outlet. Use only power source as indicated.
17. Use replacement part as specified by the manufacturer.
18. Upon completion of any service or repairs to this product, ask the service technician to perform safety checks.
19. Power Sources- this product should be operated only from the type of power source indicated on the marking label. If you are not sure of the type of power supply to your home, consult your product dealer or local power company. For products intended to operate from battery power, or other sources, refer to the operating instruction.
20. Object and Liquid Entry – Never push objects of any kind into this product through openings as they may touch dangerous voltage points or short-out parts that could result in a fire or electric shock. Never spill liquid of any kind on the product.
21. Damage Requiring Service- Unplug this product from the wall outlet and refer servicing to qualified service personnel under the following conditions:
 - a) When the power-supply adaptor or plug is damaged,
 - b) If liquid has been spilled, or objects have fallen into the product,
 - c) If the product has been exposed to rain or water,
 - d) If the product does not operate normally by following the operating instructions. Adjust only those controls that are covered by the operating instructions as an improper adjustment of other controls may result in damage and will often require extensive work by a qualified technician to restore the product to its normal operation.
 - e) If the product has been dropped or damaged in any way, and
 - f) When the product exhibits a distinct change in performance – this indicates a need for service.
22. AC adaptor is used as disconnect device and it should remain readily operable during intended use. To disconnect from the mains completely, the AC adaptor should be disconnected from the mains socket outlet completely.
23. Minimum 5 cm distances around the apparatus for sufficient ventilation.
24. The Ventilation should not be impeded by covering the ventilation openings with items, such as newspapers, tablecloths, curtains, etc.
25. No naked flame sources such as lighted candles should be placed on the apparatus.
26. Batteries should be recycled or disposed of as per state and local guidelines.
27. The use of apparatus in tropical and/or moderate climates.

SAVE THESE INSTRUCTIONS

CAUTION

CLASS 1 LASER PRODUCT

CLASS 1 LASER PRODUCT
APPAREIL LASER DE CLASSE 1
PRODUCTO LASER DE CLASE 1

CAUTION
INVISIBLE LASER RADIATION
WHEN OPEN AND INTERLOCKS
DEFEATED.
AVOID EXPOSURE TO BEAM

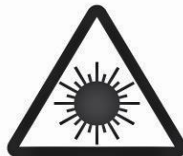

This product contains a low power laser device.

Follow the advice below for safe operations.

ON PROTECTION AGAINST LASER ENERGY EXPOSURE

- As the laser beam used in this compact disc player is harmful to the eyes, do not attempt to disassemble the casing.
- Stop operation immediately if any liquid or solid object should fall into the cabinet.
- Do not touch the lens or poke at it. If you do, you may damage the lens and the player may not operate properly.
- Do not put anything in the safety slot. If you do, the laser diode will be ON when the CD door is still open.
- This unit employs a laser. The use of controls or adjustment or performance of procedures other than those specified here may result in exposure to hazardous radiation.

ON SAFETY

- When connecting and disconnecting the AC power, grip the AC cord plastic plug and not the cord itself. Pulling the cord may damage it and create hazard.
- When you are not going to use the unit for a long period of time, disconnect the AC power cord from the wall outlet and remove all batteries.

ON AC VOLTAGE

- Before use, check that the rated voltage of your unit matches your local voltage.

ON CONDENSATION

- When left in a heated room where it is warm and damp, water droplets or condensation may form inside the CD player.
- When there is condensation inside the unit, the unit may not function normally.
- Let it stand for 1 to 2 hours before turning the power on, or gradually heat the room up and dry the unit before use.

Should any trouble occur, disconnect the AC adaptor, and refer servicing to qualified personnel.

COMPLIANCE WITH FCC REGULATIONS

FCC ID: 2A8LDJWMC280BT

This device complies with Part 15 of the FCC Rules.

Operation is subject to the following two conditions:

- (1) this device may not cause harmful interference, and
- (2) this device must accept any interference received, including interference that may cause undesired operation.

NOTE: This equipment has been tested and found to comply with the limits for a Class B digital device, pursuant to Part 15 of the FCC Rules. These limits are designed to provide reasonable protection against harmful interference in a residential installation. This equipment generates, uses, and can radiate radio frequency energy and, if not installed and used in accordance with the instructions, may cause harmful interference to radio communications. However, there is no guarantee that interference will not occur in a particular installation. If this equipment does cause harmful interference to radio or television reception, which can be determined by turning the equipment off and on, the user is encouraged to try to correct the interference by one or more of the following measures:

- Reorient or relocate the receiving antenna.
- Increase the separation between the equipment and receiver.
- Connect the equipment into an outlet on a circuit different from that to which the receiver is connected.
- Consult the dealer or an experienced radio/TV technician for help. The device has been evaluated to meet general RF exposure requirement. The device can be used in portable exposure condition without restriction.

CAUTION: Changes or modifications not expressly approved by the party responsible for compliance could void the user's authority to operate the equipment.

PROTECT YOUR FURNITURE!!

This system is equipped with non-skid rubber 'feet' to prevent the product from moving when you operate the controls. These 'feet' are made from non-migrating rubber material specially formulated to avoid leaving any marks or stains on your furniture. However certain types of oil-based furniture polishes, wood preservatives, or cleaning sprays may cause the rubber 'feet' to soften and leave marks or a rubber residue on the furniture.

To prevent any damage to your furniture we strongly recommend that you purchase small self-adhesive felt pads, available at hardware stores and home improvement centers everywhere, and apply these pads to the bottom of the rubber 'feet' before you place the product on fine wooden furniture.

DEAR JENSEN® CUSTOMER

Selecting fine audio equipment such as the unit you've just purchased is only the start of your musical enjoyment. Now it's time to consider how you can maximize the fun and excitement your equipment offers. This manufacturer and the Electronic Industries Association's Consumer Electronics Group want you to get the most out of your equipment by playing it at a safe level. One that lets the sound come through loud and clear without annoying blaring or distortion and, most importantly, without affecting your sensitive hearing.

Sound can be deceiving. Over time your hearing "comfort level" adapts to higher volumes of sound. So what sounds "normal" can actually be loud and harmful to your hearing. Guard against this by setting your equipment at a safe level BEFORE your hearing adapts.

To establish a safe level:

- Start your volume control at a low setting.
- Slowly increase the sound until you can hear it comfortably and clearly, and without distortion.

Once you have established a comfortable sound level:

- Set the dial and leave it there.

Taking a minute to do this now will help to prevent hearing damage or loss in the future. After all, we want you listening for a lifetime.

We Want You Listening For a Lifetime

Used wisely, your new sound equipment will provide a lifetime of fun and enjoyment. Since hearing damage from loud noise is often undetectable until it is too late, this manufacturer and the Electronic Industries Association's Consumer Electronics Group recommend you avoid prolonged exposure to excessive noise.



Customer's Record:

The serial number of this product is found on its back cover. You should note the serial number of this unit in the space provided as a permanent record of your purchase to aid in identification in the event of theft of loss.

Model Number: JBS-500

Serial Number: _____

LOCATION OF CONTROLS

Main unit

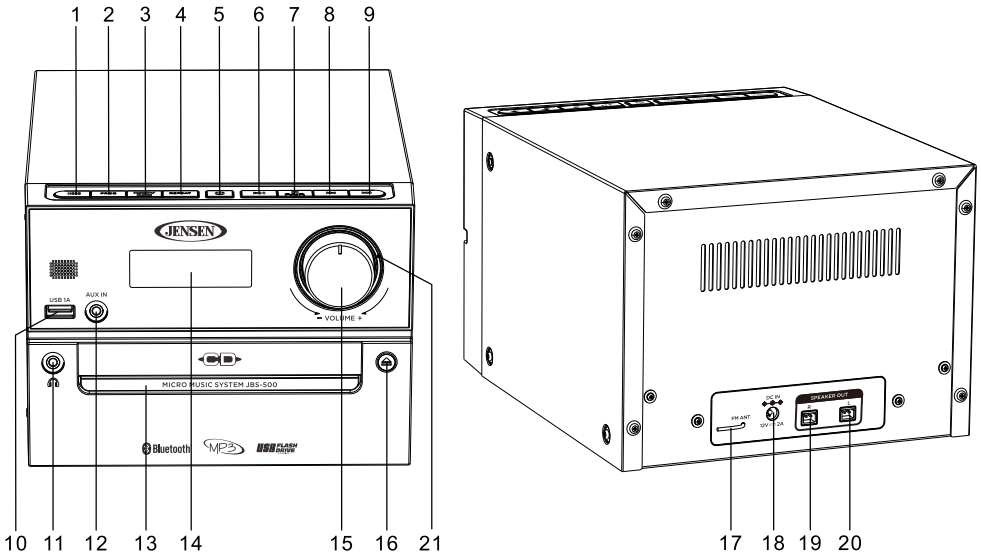

1. MODE BUTTON	12. AUX IN JACK
2. CD/FM PROGRAM BUTTON	13. CD TRAY
3. FM PRESET+ / CLOCK SET BUTTON	14. LCD DISPLAY
4. CD/USB REPEAT BUTTON	15. VOLUME CONTROL KNOB
5. ⏻ POWER ON/STANDBY BUTTON	16. CD TRAY OPEN /CLOSE ▲ BUTTON
6. CD/USB/BLUETOOTH PLAY/ PAUSE ▶ / RADIO AUTO SEATCH BUTTON	17. FM WIRED ANTENNA
7. CD: STOP ■ BUTTON/ BLUETOOTH: PAIR BUTTON FM: MONO/STEREO BUTTON	18. DC IN JACK
8. CD/USB/BLUETOOTH SKIP I◀◀ PREVIOUS/ TUNE- BUTTON ▶▶I	19. RIGHT SPEAKER CONNECTOR
9. CD/USB/BLUETOOTH SKIP NEXT/ TUNE+ BUTTON	20. LEFT SPEAKER CONNECTOR
10. USB PORT FOR PLAYBACK/ 1A CHARGING IN STANDBY MODE	21. POWER INDICATOR (RED VOLUME RING)
11. HEADPHONE JACK	

Remote control

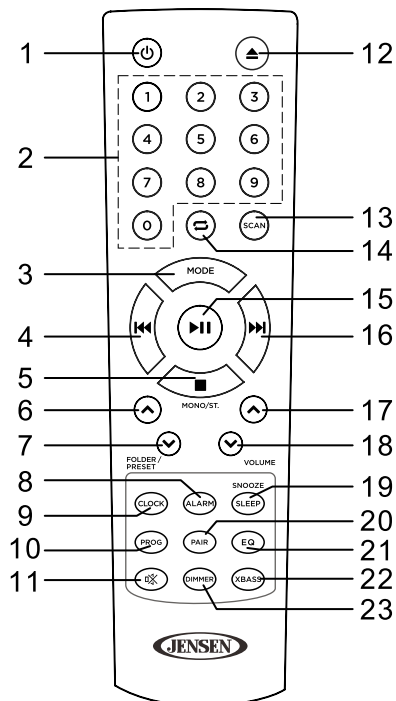

1. ⏻ POWER/STANDBY BUTTON	13. FM SCAN BUTTON
2. NUMERICS KEY PAD	14. 🔄 CD/USB REPEAT BUTTON
3. MODE BUTTON	15. CD/USB/BLUETOOTH PLAY/ PAUSE BUTTON ⏸
4. CD/USB/BLUETOOTH SKIP ⏮ PREVIOUS/ TUNE- BUTTON	16. CD/USB/BLUETOOTH SKIP ⏭ NEXT/ TUNE+ BUTTON
5. CD: STOP ■ BUTTON/ FM: MONO/STEREO BUTTON	17. VOLUME UP ▲ BUTTON
6. FOLDER/PRESET UP ▲ BUTTON	18. VOLUME DOWN ▼ BUTTON
7. FOLDER/PRESET DOWN ▼ BUTTON	19. SNOOZE/SLEEP BUTTON
8. ALARM BUTTON	20. BLUETOOTH PAIR BUTTON
9. CLOCK BUTTON (CLOCK SET)	21. EQ BUTTON
10. PROG BUTTON	22. XBASS BUTTON
11. MUTE 🔇 BUTTON	23. DIMMER BUTTON
12. CD TRAY OPEN /CLOSE ▲ BUTTON	

CONNECTIONS

Make sure the AC adaptor is unplugged from the wall outlet before making any connections.

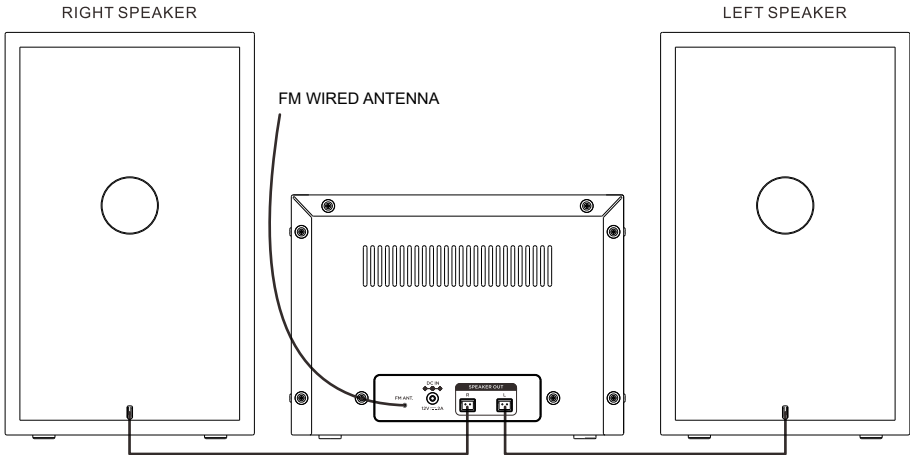

GETTING STARTED

INCLUDED ITEMS

Carefully remove the unit and all items from the package.

Please verify that you have all following accessories before recycling the gift box.

- Main Unit
- 2 x Speakers
- User Manual
- Remote Control
- 2 x AAA Batteries
- AC-DC Adaptor

Connecting the Speakers

Each speaker cable has a plug on the end that fits into the speaker connector located on the back of the main unit. Make sure the little tab on the top of the plug is facing up when inserting it into the connector. The plug goes in only one way, so do not force the plug into the connector or it may cause damage.

Power source

This unit operate on AC 120V ~ 60Hz AC-DC adaptor household current and requires 2x 1.5V AAA size battery (included) for the remote control. Do not attempt to operate the unit from any other power source. You could cause damage to the unit and void your warranty.

AC Power Connection

Plug the AC-DC adaptor into an available 120V ~ 60Hz AC Outlet. Make sure the plug is securely inserted into the AC outlet.

Remote Control

The remote control operates 2 x 1.5V AAA size batteries (included). If the remote operation becomes intermittent or unsatisfactory, replace the original batteries with new batteries.

- 1.) Open the battery compartment cover.
- 2.) Insert two "AAA" (UM-4) batteries (included) and observe the polarity as indicated inside the battery compartment when installing.
- 3.) Replace the cover.

CAUTION:

- 1.) Danger of explosion if the battery is replaced incorrectly.
- 2.) Replace only with the same or equivalent type battery.

NOTE: Only use a well-known brand of batteries to ensure the longest life and best performance.

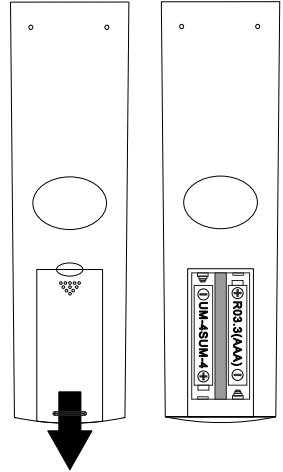

Battery Precautions

- Replacement of batteries must be done by an adult.
- Do not mix old and new batteries.
- Do not mix alkaline, standard (carbon-zinc) or rechargeable (nickel-cadmium) batteries.
- If the batteries in the device have expired or the device is not to be used for a long period of time, remove the battery to prevent damage or injury from possible battery leakage.
- The supply terminals are not to be short-circuited.
- Non-rechargeable batteries are not to be recharged.
- Exhausted batteries are to be removed.
- Only batteries of the equivalent type are to be used.
- Batteries are to be inserted with the correct polarity.
- Dispose of batteries properly. Do not dispose of batteries in fire or leave in direct sunlight. The batteries may explode or leak.
- Clean the contacts of the batteries and the contacts in the device prior to battery installation.

NOTE ON NON-MAGNETICALLY SHIELDED SPEAKERS

This unit is not magnetically shielded and may cause color distortion on the screen of some TVs or video monitors. To avoid this, you may need to move the unit further away from the TV or monitor if unnatural color shifts or image distortion occurs.

STANDBY MODE

Standby Mode is when the unit is first plugged into an AC power source, display shows 12:00AM and flashing or after all the settings have been made and the time is showing on the display.

Standby mode is also enabled when the **⏻ POWER/ STANDBY Button** is pressed and all the functions (CD/ USB/ Bluetooth/ FM/ AUX) are off, no buttons are pressed and no alarms are sounding.

TURNING THE UNIT ON/OFF

1. In Off (standby) mode, tap the **⏻ POWER/STANDBY Button** on main unit or remote control to turn the unit ON. The unit will turn on, the last selected input mode icon will show on LCD display, power indicator (red volume ring) will light.
2. To turn the unit OFF (standby), tap the **⏻ POWER/STANDBY Button** on the main unit or remote control again. The power indicator (red volume ring) will be off and LCD display will change to show the current time.

SETTING THE CLOCK

After plugging in the AC power, "12:00" will be flashing on the LCD display.

1. In power off (standby) mode, press and hold the **CLOCK Button** on remote control or main unit, the 12 HOUR format "SET 12H" will show in display and "12H" will be flashing to prompt for input.
2. Tap the **⏪ or ⏩ Button** on remote control or main unit to select 24 Hour format if necessary. Otherwise, press the **CLOCK Button** to confirm 12 Hour clock format and enter clock setup mode, Hour digits will be flashing.
3. Tap the **⏪ or ⏩ Button** on remote control or main unit to adjust the hour. Press and hold the button for fast advance/ reverse setting.
Note: Make sure the hour is set so that the AM/PM indicator is displayed correctly.
4. Press the **CLOCK Button** on remote control or main unit to confirm the hour setting, the minute digits will flash to prompt for input.
5. Tap the **⏪ or ⏩ Button** on remote control or main unit to adjust the minute. Press and hold the button for fast advance/ reverse setting.
6. Press the **CLOCK Button** again to complete the setting.

CHECKING THE CLOCK

The unit will show the current time in standby mode. To check the current time in Power on mode, press **CLOCK Button** on remote control or main unit, the current will show for 3 seconds and then return to the previous screen.

ALARM OPERATION (REMOTE CONTROL ONLY)

SETTING THE ALARM CLOCK

This function allows the system to turn on automatically and wake you using a beeping alarm (BEEP), DISC (CD), USB, or FM radio.

1. In standby mode, press and hold **ALARM Button** on remote control, the alarm icon ☹ and alarm time 12:00 will appear in display. Hour digits of alarm clock start flashing.
2. Press the ⏪ or ⏩ **Button** to set the hour and then press the **ALARM Button** again to confirm, Minute digits will be flashing.
Note: Make sure the hour is set so that the AM/PM indicator is displayed correctly.
3. Press the ⏪ or ⏩ **Button** to set the minute and then press the **ALARM Button** again to confirm, alarm wake up course will appear in display.
4. Press the ⏪ or ⏩ **Button** to select wake to BEEP, DISC, USB, or FM and then press the **ALARM Button** again to confirm, alarm volume level will be flashing.
5. Press the ⏪ or ⏩ **Button** to set the wake-up alarm volume level and then press the **ALARM Button** to finish alarm setup. An alarm icon ☹ shows on display steadily.

Note:

- 1.) If wake-up source is selected DISC or USB, but a CD or USB is not inserted, the alarm will default to the Beeping alarm automatically when the alarm wake time is reached.
- 2.) For wake-up source selected FM, the system will default to the last FM radio station listened to before switching off.

ACTIVATE/ DE-ACTIVE ALARM FUNCTION

1. To active ALARM, tap the **ALARM Button** once in Standby mode, the alarm icon ☹ will show on LCD display.
2. To cancel the ALARM, tap the **ALARM Button** in Standby mode, the alarm icon ☹ will goes off from LCD display.

Wake to Beeping Alarm, DISC, USB, or FM

- When the alarm time is reached, the CD, USB, FM, or beeping alarm will sound for 60 minutes then shut off and reset itself for the following day (without press the snooze button).
- To stop the alarm immediately after it sounds, tap the ⏻ **POWER/STANDBY Button** on remote control or main unit. The alarm will now reset for the following day.
- To cancel the following day alarm, tap the **ALARM Button** once, the ALARM icon ☹ on the display goes off.

SNOOZE FUNCTION

Press **SNOOZ/SLEEP button** on remote control to activate the SNOOZE function and temporarily stop the alarm from sounding for 10 minutes. The ALARM icon ☹ will keep flashing in SNOOZE period and the alarm will re-start again after 10 minutes on each press. To cancel the SNOOZE mode, press the ⏻ **Power Button** once, the ALARM icon ☹ will goes steadily.

Note: The SNOOZE feature is only active for 60 minutes after the original alarm time. You can press **SNOOZE button** again multiple times as long as it's within that 60 minutes active period, and as long as a minimum of 10 minutes remain. Once the 60 minutes expires, the alarm will stop until next day.

LISTENING TO RADIO

1. Tap the **⏻ POWER/STANDBY Button** on main unit or remote control to turn on the unit.
2. Tap the **MODE Button** on main unit or remote control to select FM mode. The FM frequency appear in display.
3. To manual tune to a specific radio station, tap the **⏮/⏭ Button** on either main unit or remote control repeatedly. Use the manual tuning method to tune in weaker stations that are bypassed during automatic tuning.
4. To automatically tune to the next available radio station, press and hold **⏮/⏭ Button** on main unit or remote control for 1-2 seconds until frequency readout on the display begins to scan and then release the button. The tuner will stop scanning when it receives the next broadcasting station of adequate signal strength.
5. Rotate the **VOLUME** knob on main unit or press the **VOLUME ▲/▼ Button** on remote control to adjust the volume control to the desired volume level.

FM/ FM Stereo reception

When listening to the FM radio, press the **■ Button** on main unit or remote control to switch between stereo mode (ST) and mono mode (MONO). It is preferable to receive the program in mono when you are receiving a weak station.

HINTS FOR BEST RECEPTION:

For best FM reception, the FM lead wire antenna located on the back of the unit should be fully unwrapped and extended.

NOTE: Automatic tuning depends on the signal strength of the broadcasting station, so weak stations may be skipped. You can manually tune to find the weak stations if a station gets skipped. With strong signals, the tuner may stop before it reaches the actual broadcast frequency, so you may need to manually tune for the best reception.

PRESET RADIO STATIONS

1. Tap the **⏻ POWER/STANDBY Button** on main unit or remote control to turn on the unit.
2. Tap the **MODE Button** on main unit or remote control to select FM mode.
3. Press and hold **▶|| Button** on main unit or **SCAN Button** remote control to perform auto search and program preset channels. "PROG" appears in display and flashing. Auto searching and programming will stop at PROG 01 after scan finished, "PROG" shows in display steadily.

Note: If the channels stored during the auto search but programmed preset are not your favorites, use the method below for the manually saving radio presets.

4. Tune to the desired radio station either by "manually" or "automatically" tuning method.

5. Tap the **PROG Button** on the main unit or remote control, the next available preset memory number and a flashing "PROG" text will show in the LCD display. (Note: "P01" will show in the display if you are programming preset for first time)
6. Tap the **PRESET+ Button** then using **◀/▶ Button** on main unit or **PRESET ▲/▼Button** on remote control to select the preset number you want to assign the station to.
7. Tap the **PROG Button** to confirm the setting.
8. Repeat above steps 4-7 to preset up to 40 FM stations.

RECALLING PRESET MEMORY CHANNELS

In FM mode, recall the pre-set channels by pressing the **PRESET+ button** or **PRESET ▲/▼Button** on remote control repeatedly.

You can also press the numerics button on remote control to recall the preset station. Once you inputted preset station number, then press **▶|| Button** to confirm the selection.

CD/MP3 OPERATION

PLEASE READ THIS IMPORTANT INFORMATION:

CD mechanisms used in devices like this are designed to read all commercial CDs. It will also read self-compiled CD-R/CD-RW discs, but it may take up to 10 seconds for the actual playback to begin. If playback does not start, it is likely due to the quality of the CD-R/RW disc and/or the compatibility of the CD compilation software. The manufacturer is not responsible for the playback quality of CD-R/RW discs.

- Do not attach a label or seal to either side of the CD-R/RW disc. It may cause a malfunction.
- Due to the numerous different file systems and file formats, connected USB memory sticks cannot be guaranteed to function.
- Supported file systems is FAT32. The supported file format is MP3.

FOR WINDOWS USERS:

- When using the "Burn a CD" feature to create an MP3 CD in Windows, you must select the "With a CD/DVD player" option when it asks "How do you want to use the disc?" The MP3 CD will not play on this unit if you select the "Like a USB flash drive" option or if the MP3 CD is not finalized.

PLAYING A CD

1. Press the **⏻ POWER/STANDBY Button** on main unit or remote control to turn on unit.
2. Tap the **MODE Button** on main unit or remote control to select DISC mode and then press the Open/Close **▲ Button** to open CD tray.
3. Place an audio CD inside the CD tray with its printed side facing up.

4. Press the **▲ Button** to close the CD tray. Unit starts to read the disc, "READ" shows in display. After few seconds, the total number of tracks and total time of the CD will be shown on the LCD display.

IMPORTANT: Only use the ▲ Button for opening and closing the CD tray. Do not push on the CD tray to close it after loading a CD. This could damage the internal mechanism used for opening and closing the CD tray.

5. Press the **PLAY/PAUSE ►|| Button** on main unit or remote control, the CD will start playing from first track.
6. Rotate the **VOLUME** knob on main unit or **VOLUME ▲/▼ Button** on remote control to adjust the desired volume level.
7. To pause playback, press the **PLAY/PAUSE ►|| Button** on main unit or remote control. The track time will be pause and track timing will keep flashing. To resume playing, press the CD **PLAY/PAUSE ►|| Button** again.
8. You can choose to play your favorite track directly by pressing either the **SKIP NEXT ►►** or **SKIP PREVIOUS ◀◀ Button**. The LCD display will indicate the correct track number selected.
9. To locate a particular section within a track, press and hold the **◀◀** or **►► Button** until the section is found. Release the button to continue playing your selection.
10. To stop playing, press the **STOP ■ Button**.
11. Turn off the **JBS-500** when you finish listening.

SKIP AND SEARCH MODE

For CD:

1. During Play or Pause mode, tap the **SKIP NEXT ►►** or **SKIP PREVIOUS ◀◀ Button** to go to the next track or go back to the beginning of the current track.
2. During playback, press and hold the **◀◀** or **►► Button** to search within the current track with audible high-speed playback.

For MP3-CD:

1. Tap **PRESET+ Button** on main unit repeatedly or **FOLDER ▲/▼ Button** on remote control to select MP3 songs store in different folders.
2. Tap the **SKIP NEXT ►►** or **SKIP PREVIOUS ◀◀ Button** to go to the next track or go back to the beginning of the current track.

DIFFERENT PLAY MODES (CD/ MP3-CD/ USB)

Press the **REPEAT Button** on main unit or **⏮ Button** on remote control repeatedly to select different of play modes when CD/USB is playing.

When playing CD, the play modes are shown as below.

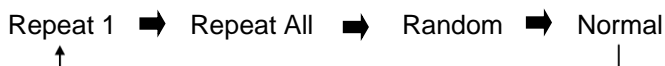

When playing MP3 CD/USB, the play modes are shown as below.

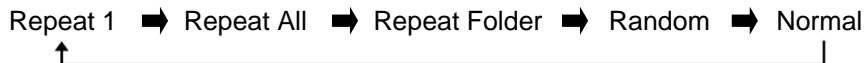

REPEAT 1 – the track being played and will repeat continuously.
Repeat one icon “REP” flashing in display.

REPEAT ALL – all tracks will repeat continuously.
Repeat All icon “REP ALL” flashing in display.

REPEAT FOLDER – current folder will repeat continuously.
Repeat folder icon “REP ALB” flashing in display.

RANDOM – the tracks in the CD/USB will be played in random sequency.
Random icon “RAND” flashing in display.

PLAY TRACK SEQUENCE PROGRAMMING

This function allows the tracks to be played in a programmed sequency.

NOTE: Program can only be set in STOP mode.

1. Tap the **PROG Button** on main unit or remote control, the program number “P-01” shows in display, “PROG” icon and CD track number “01” also flashing in the LCD display.
2. For MP3 tracks, press **PRESET+ Button** on main unit repeatedly or **PRESET ▲/▼Button** on remote control to select an album or a folder
3. Use the **⏮** or **⏭ Button** on main unit or remote control to select the desired track. The track number will be shown in display.
4. Tap the **PROG Button** on main unit or remote control to store the selected track in the memory, the next program number will advance on (i.e., “P-02”) in LCD display.
5. Repeat steps 2 to 3 to store more tracks in the memory. You can store up to 32 CD tracks or 99 MP3 tracks. Display will show “FULL” after 32 tracks have been programmed.
6. Tap the **▶|| Button** on main unit or remote control to start playing the CD in the programmed sequence.
7. Press the **REPEAT Button** on main unit or **↺ Button** on remote control to select different play modes if necessary.
8. To stop playback, press the **STOP ■ Button** on main unit or remote control.
9. To erase the program, in the stop position, press **STOP ■ Button** on main unit or remote control twice, “PROG” icon disappears from display and shown “CLEAR”.

USB OPERATION

PLAYBACK OF MP3 SONGS VIA THE USB THUMB DRIVE

NOTE: Inserting the USB drive upside down or backwards could damage the audio system or the storage media (USB thumb drive). Check to be sure the direction is correct before connection.

1. Make sure the unit is off or in USB mode, plug-in the USB thumb drive and make sure it is fully inserted.
2. Turn on unit again if it is power off to select USB mode by tap the **MODE Button** on main unit or remote control repeatedly. The unit will start reading MP3 songs stored on the thumb drive automatically after connecting, and LCD display will show the total folders and tracks of MP3 files being detected.

3. Press the **PLAY/PAUSE ►II** button on main unit or remote control to start playback.
4. Operating the same playback procedures of Play/Pause, Repeat, Random, Program tracks as playing MP3 CD disc which mentioned in “CD OPERATION” section above.

Notes:

- The unit will only detect and read files in MP3 format. No other file formats are supported.
- If connecting the system to an MP3 player via the USB port, some MP3 player formats may not be playable due to variances in the MP3 encoding format. This is not a malfunction of the unit.
- The USB port does not support connection with USB extension cable and is not designed for communication with computer or external hard drive directly.
- Compatible USB thumb drive: FAT32, up to 128GB memory.

1A USB charging function works in Standby and USB mode.

You can charge your device through the USB port on this product with a USB cable (Not supplied).

Note:

- The maximum current for USB charging is 1A.
- Not all devices for USB charging are guaranteed.

BLUETOOTH OPERATION

Press the **⏻ POWER/STANDBY Button** to turn ON the unit and follow the directions below to connect via Bluetooth.

PAIRING (Linking) a BLUETOOTH ENABLED cell phone OR OTHER BLUETOOTH ENABLE DEVICE to the JBS-500

If the JBS-500 has never been paired with a Bluetooth device before, you need to follow the pairing instruction below to link the JBS-500 with your Bluetooth device.

1. Press the **⏻ POWER/STANDBY Button** on main unit or remote control to turn on the unit.
2. Tap the **MODE Button** on main unit or remote control to select Bluetooth mode (BT).
3. If the **JBS-500** has never been paired with a Bluetooth device before or cannot find the last paired device, the flashing (BT) on LCD will indicate the **JBS-500** is in search mode. You need to follow the pairing instructions below to link the **JBS-500** with your Bluetooth device.
 - Turn on the Bluetooth function of your Bluetooth device and enable the search or scan function to find the **JBS-500**.
 - Select “**JBS-500**” from the device list when it appears on your device screen. IF required, enter the pass code “0000” to pair (link) the JBS-500 with your device.
4. After successfully pairing (linking), display will change to show “BT” steadily. You can begin playing music from your Bluetooth device wirelessly to the speaker.

5. After selecting your favorite song, press **▶II Button** on main unit or remote control to start playing and adjust the volume level from paired device.
6. Rotate the **VOLUME knob** on main unit or **VOLUME ▲/▼Button** on remote control to adjust the desired volume level.
7. Press **⏮** or **⏭ Button** on main unit or remote control to skip to previous or next song.
8. If you want to pair the **JBS-500** with another Bluetooth enabled device, press and hold the **PAIR Button** on remote control or **■/PAIR Button** on main unit for 3 seconds or turn off Bluetooth function of device currently paired with **JBS-500** then repeat step 3 above.

Notes:

- 1.) Refer to the manual of your cell phone, tablet PC, computer or other Bluetooth enabled devices for Bluetooth operation since it may vary from model to model.
- 2.) If your Bluetooth enable device does not support A2DP profile, it will not play the music through the speaker, even if paired (linked).
- 3.) If you are pairing (linking) your computer to the unit using Bluetooth, you may need to set the speaker as your computer's default sound device.

AUXILIARY INPUT OPERATION

This unit features an auxiliary audio signal input jack for connection external audio devices like MP3 players, Digital Audio Device and listen to them through the speakers of this unit.

1. Use an audio cable (not included) with one 3.5mm stereo plug on each end of the cable.
2. Plug one end into the AUX-IN jack on the main unit and the other end of the cable into the Lineout jack or headphone jack of your external audio device.
3. Turn on the unit and external audio device.
4. Tap the **MODE Button** on main unit or remote control to select AUX-IN mode.
5. The volume level can now be controlled through the main unit. Operate all other functions on the auxiliary device as usual.

Note:

- If you connect this unit to the Line-Out jack of your external device, then you only need to adjust the volume control of this unit.
If you connect the headphone jack of your external device, then you may need to adjust both the volume controls of your external device and this unit to obtain the desirable volume setting.
- Press the **⏻ POWER/STANDBY Button** on main unit or remote control to turn off the unit when you have finished listening. Don't forget to switch off the power of your external device as well.





PRESET EQ / XBASS (REMOTE CONTROL ONLY)

This unit provides 4 different EQ modes to enhance your listening experience. You can select the desired effect by pressing the **EQ button** on remote control repeatedly at following sequence:



- Press **XBASS Button** on remote control to activate BASS effects if necessary. X-BASS icon **X-BASS** will show in display when enabled.
- Press again to deactivate the BASS effects until the X-BASS icon disappeared.

MUTE BUTTON (REMOTE CONTROL ONLY)

- Press the MUTE  **Button** on remote control to mute the sound output from the speaker temporarily. The MUTE message will appear in display.
- Press MUTE  **Button** or VOLUME / **Button** on remote control to restore the volume.

SLEEP OPERATION (REMOTE CONTROL ONLY)

The sleep timer allows you to turn the unit off after a designated time is reached.

1. To activate the sleep timer, turn the unit on and tap the **MODE** Button to select DISC, USB, BT, or USB or listening to music via AUX-IN.
2. Tap the **SLEEP** Button on remote control, the sleep icon “zZZ” appears on the display.
3. Repeatedly tap the **SLEEP** Button to select sleep time. The unit will turn off after 120 to 10 minutes. Wait for a seconds after your selection for the unit to confirm the selection, the unit will play for the selected length of time then automatically turn off.
4. To cancel the sleep timer, tap the **SLEEP** Button repeatedly unit timer shows “OFF”, the sleep time icon “zZZ” disappears on the display.
5. To turn the unit off before the selected length of time, press the  **POWER/STANDBY** Button at any time.

Notes:

- 1.) To check the remaining sleep time, press the **SLEEP** Button once.
- 2.) If you are falling asleep to music from an external device connected to the AUX input, the sleep timer will shut off the power to this system, but it will not turn off the external device.

USE HEADPHONES (NOT INCLUDED)

Connect the plug of the stereo headphone (not included) into the Stereo headphone Jack

 will enable you to listen the music in private. When using headphones, the sound from the speaker set will be disconnected.

READ THIS IMPORTANT INFORMATION BEFORE USING YOUR HEADPHONES

1. Avoid excessive volume levels for long period of time when using the headphones. Prolonged use at high levels may impair your hearing.
2. Do not use earphones while operating a motorized vehicle, as it may create a traffic hazard and is illegal in many areas.
3. Keep the volume at a reasonable level even if your headset is an open-air designed to allow you to hear outside sounds. Please note that excessively high volume may still block outside sounds.

ADJUST DISPLAY BRIGHTNESS (REMOTE CONTROL ONLY)

Press **DIMMER Button** on remote control repeatedly to adjust the display brightness level.

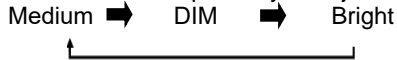

RESETTING THE UNIT

If the system does not respond or has erratic operation, you may have experienced an electrostatic discharge (ESD) or a power surge that triggered the internal MCU to shut down automatically. If this occurs, unplug the AC-DC adaptor from the AC outlet and wait for 60 seconds, then plug the AC-DC adaptor back into the AC outlet. The unit is now reset. You need to reset the clock and alarm after reset.

CHARGING YOUR SMART PHONE OR PORTABLE DEVICE

This unit features a 1 AMP (1000mA) USB charging port for charging your portable device (iPod, iPhone, Android phone, etc.) when unit in **STANDBY and USB MODE**.

Use with the USB charging cable that came with your device (not supplied) for charging.

1. Turn the unit to STANDBY or USB mode. Plug one end of the USB cable (not included) into the **USB Charging Port** located on the front panel of the unit. Plug the other end of the cord into the device you wish to charge.
2. Observe the battery charge indicator on your device to make sure the charging process starts normally.
3. Unplug the cable when your device is fully charged.

CAUTION:

USB charging works in Standby and USB mode. Before charging, please refer to the user manual of the device you wish to charge to make sure the charging current requested does not exceed 1.0A (1000mA). Overloading the charging circuit may damage the unit permanently and void the warranty.

1. The USB charging port of this unit supplies a DC 5V output at 1000 mA maximum current to charge your smart phone or portable device battery and it cannot support any other voltage range.
2. Make sure the device you want to charge has a battery charge rating of DC 5V only.
3. The USB port of this unit is designed for smart phone or portable device battery charging only and it cannot support data transfer or connect to computer.
4. Do not connect the USB port of this unit to other external power charger USB ports, it may damage both units and void the warranty.

Note:

- 1.) Some smart phones and portable devices use proprietary USB connections and circuitry, so they may not charge when plugged into the USB port. Please refer to your device user manual before you attempt to charge them.
- 2.) It is normal if the unit gets warm while the USB port is in use and charging your smart phone or portable device.
- 3.) Do not charge your smart phone over 12 hours continuously. Disconnect your smart phone or other portable device from the USB cord once it is fully charged.

CARE AND MAINTENANCE

1. Do not subject the unit to excessive force, shock, dust, or extreme temperature.
2. Do not tamper the internal components of the unit.
3. Clean your unit with a dry cloth. Solvent or detergent should never be used.
4. Avoid leaving your unit in direct sunlight or in hot, humid, or dusty places.
5. Keep your unit away from heating appliances and sources of electrical noise such as fluorescent lamps or motors.
6. If dropouts or interruptions occur in the music during CD play, or if the CD fails to play at all, its bottom surface may require cleaning. Before playing, wipe the disc from the center outwards with a good soft cleaning cloth.

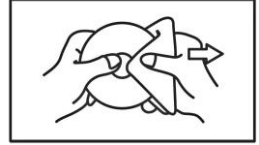

CLEANING THE UNIT

- To prevent fire or shock hazard, disconnect your unit from the AC power source when cleaning.
- The finish on the unit may be cleaned with a dust cloth and cared for as other furniture. Use caution when cleaning and wiping the plastic parts.
- If the cabinet becomes dusty wipe it with a soft dry dust cloth. Do not use any wax or polish sprays on the cabinet.
- If the front panel becomes dirty or smudged with fingerprints it may be cleaned with a soft cloth slightly dampened with a mild soap and water solution. Never use abrasive cloths or polishes as these will damage the finish of your unit.

CAUTION: Never allow any water or other liquids to get inside the unit while cleaning.

TROUBLESHOOTING GUIDE

If you experience difficulties in the use of this Music System, please check the following or call 1-800-777-5331 for technical support.

Symptom	Possible Problem	Solution
Unit does not respond (no power)	AC ADAPTOR is not plugged properly into a wall outlet, or the AC-DC connector is not plugged into the DC socket at the back of the System.	Re-plug the AC adaptor into the wall outlet and the DC connector into DC socket on the System.
	Wall outlet is not functioning.	Plug another device into the same outlet to confirm the outlet is working.
Bluetooth: No sound	Bluetooth speaker is not linked with the playable device. Speaker placement out of range.	Go through the "Bluetooth Operations" process to link the speakers. Relocate the speaker within Bluetooth operating range.
Radio no sound	Unit not in FM mode. Volume set at minimum	Tap MODE button to select FM mode. Increase Volume.



Symptom	Possible Problem	Solution
Noise or sound distorted on FM broadcast	FM wire antenna is not fully extended.	Retune the FM broadcast station. Fully extend or reposition the FM wire antenna.
CD player does not play	Unit not in DISC function mode. Audio disc is installed incorrectly. If the disc is self-compiled, the media used may not be compatible with the player.	Select DISC mode. Insert audio disc with label side up. Use better quality blank media and retest.
Audio disc skips while playing	Disc is dirty or scratched.	Wipe disc with clean cloth or use another disc.
Intermittent sound from the player	Dirty or defective disc Dirty pick-up lens Player is subject to excessive shock or vibration	Clean or replace the defective disc. Use a lens cleaning disc to clean the lens. Relocate the player away from shock or vibration.
Sound is distorted	Volume level is set too high. Sound source is distorted.	Decrease the volume. Try a different sound source. If you are using an external sound source like older generation of iPod, try reducing the output volume on the device itself. Also try turning XBASS OFF or change the EQ setting.
Unit gets warm after extended play at high volume	This is normal.	Turn the unit off a period of time or lower volume.

SPECIFICATIONS

Power Requirement

AC Adaptor:

Input: AC 120V~ 60Hz

Output: DC 12V  2A 

Remote control:

2 x 1.5V "AAA" (UM-4) batteries

Frequency Range

Radio Band

FM 87.5 - 108 MHz

Bluetooth:

Version 5.0

USB Charging (Work in standby and USB mode only)

USB Output:

DC 5V  1.0A (1000mA)

The *Bluetooth*® word mark and logos are registered trademarks owned by Bluetooth SIG, Inc. and any use of such marks by Spectra Merchandising Intl, Inc. is under license. Other trademarks and trade names are those of their respective owners.

**90 DAY LIMITED WARRANTY AND SERVICE
VALID IN THE U.S.A. ONLY**

EASY BUYS ELECTRONICS INC warrants this unit to be free from defective materials or factory workmanship for a period of 90 days from the date of original customer purchase and provided the product is utilized within the U.S.A. This warranty is not assignable or transferable. Our obligation under this warranty is the repair or replacement of the defective unit or any part thereof, except batteries, when it is returned to the EASY BUYS ELECTRONICS INC Service Department, accompanied by proof of the date of original consumer purchase, such as a duplicate copy of a sales receipt.

You must pay all shipping charges required to ship the product to EASY BUYS ELECTRONICS INC for warranty service. If the product is repaired or replaced under warranty, the return charges will be at EASY BUYS ELECTRONICS INC's expense. There are no other express warranties other than those stated herein. This warranty is valid only in accordance with the conditions set forth below:

1. The warranty applies to the EASY BUYS ELECTRONICS INC product only while:
 - a. It remains in the possession of the original purchaser and proof of purchase is demonstrated.
 - b. It has not been subjected to accident, misuse, abuse, improper service, usage outside the descriptions and warnings covered within the user manual or non-EASY BUYS ELECTRONICS INC approved modifications.
 - c. Claims are made within the warranty period. This warranty does not cover damage or equipment failure caused by electrical wiring not in compliance with electrical codes or EASY BUYS ELECTRONICS INC user manual specifications, or failure to provide reasonable care and necessary maintenance as outlined in the user manual.
2. Warranty of all EASY BUYS ELECTRONICS INC products applies to residential use only and is void when products are used in a nonresidential environment or installed outside the United States.
3. For repair or replacement information, please contact EASY BUYS ELECTRONICS INC by phone at **1-818-388-0174** or by email at **easybuys123@gmail.com**. In some cases the model you have may be discontinued, and EASY BUYS ELECTRONICS INC reserves the right to offer alternative options for repair or replacement.
4. For product technical support only, please contact Spectra Merchandising International at: **1-800-777-5331**.

Easy Buys Electronics Inc - Returns
990 E. Mill Street San Bernardino,
CA 92408

1022

Printed in China