

JENSEN®

DOCKING DIGITAL MUSIC SYSTEM FOR iPod®



OWNER'S MANUAL JiMS-125

(iPod® Not Included)

PLEASE READ THIS OPERATING MANUAL COMPLETELY BEFORE OPERATING
THIS UNIT AND RETAIN THIS BOOKLET FOR FUTURE REFERENCE

TABLE OF CONTENTS

DEAR JENSEN® CUSTOMER	2
IMPORTANT SAFETY INSTRUCTIONS	3
COMPLIANCE WITH FCC REGULATIONS	5
PRODUCT FEATURES	6
INSTALLATION	7
LOCATION OF CONTROLS	8
CLOCK SETTING	10
ALARM OPERATIONS	10
RADIO OPERATIONS	12
iPod DOCKING	13
AUXILIARY INPUT	14
CARE AND MAINTENANCE	15
TROUBLESHOOTING GUIDE	16
SPECIFICATIONS	17
SERVICE	17

"Made for iPod" means that an electronic accessory has been designed to connect specifically to iPod and has been certified by the developer to meet Apple performance standards.

Apple is not responsible for the operation of this device or its compliance with safety and regulatory standards.

iPod is a trademark of Apple Inc., registered in the U.S. and other countries.

DEAR JENSEN[®] CUSTOMER

Selecting fine audio equipment such as the unit you've just purchased is only the start of your musical enjoyment. Now it's time to consider how you can maximize the fun and excitement your equipment offers.

This manufacturer and the Electronic Industries Association's Consumer Electronics Group want you to get the most out of your equipment by playing it at a safe level. One that lets the sound come through loud and clear without annoying blaring or distortion and, most importantly, without affecting your sensitive hearing.

Sound can be deceiving. Over time your hearing "comfort level" adapts to higher volumes of sound. So what sounds "normal" can actually be loud and harmful to your hearing. Guard against this by setting your equipment at a safe level BEFORE your hearing adapts.

To establish a safe level:

- Start your volume control at a low setting.
- Slowly increase the sound until you can hear it comfortably and clearly, and without distortion.

Once you have established a comfortable sound level:

- Set the dial and leave it there.

Taking a minute to do this now will help to prevent hearing damage or loss in the future. After all, we want you listening for a lifetime.

We Want You Listening For a Lifetime

Used wisely, your new sound equipment will provide a lifetime of fun and enjoyment. Since hearing damage from loud noise is often undetectable until it is too late, this manufacturer and the Electronic Industries Association's Consumer Electronics Group recommend you avoid prolonged exposure to excessive noise.

Customer's Record:

The serial number of this product is found on its bottom cover. You should note the serial number of this unit in the space provided as a permanent record of your purchase to aid in identification in the event of theft or loss.

Model Number: JiMS-125

Serial Number: _____

IMPORTANT SAFETY INSTRUCTIONS

When used in the directed manner, this unit has been designed and manufactured to ensure your personal safety. However, improper use can result in potential electrical shock or fire hazards. Please read all safety and operating instructions carefully before installation and use, and keep these instructions handy for future reference. Take special note of all warnings listed in these instructions and on the unit.

1. Water and Moisture

The unit should not be used near water. For example: near a bathtub, washbowl, kitchen sink, laundry tub, swimming pool or in a set basement.

2. Ventilation

The unit should be situated so that its location or position does not interfere with its proper ventilation.

For example, it should not be situated on a bed, sofa, rug or similar surface that may block the ventilation openings. Also, it should not be placed in a built-in installation, such as a bookcase or cabinet, which may impede the flow of air through the ventilation openings.

3. Heat

The unit should be situated away from heat sources such as radiators, heat registers, stoves or other appliances (including amplifiers) that produce heat.

4. Power Source

The unit should be connected to a power supply only of the type described in the operating instructions or as marked on the appliance.

5. Power Cord Protection

Power supply cords should be routed so that they are not likely to be walked on or pinched by items placed upon or against them. It is always best to have a clear area from where the cord exits the unit to where it is plugged into an AC outlet.

6. Cleaning

The unit should be cleaned only as recommended. See the section "Care and Maintenance" of this manual for cleaning instructions.

7. Object and Liquid Entry

Care should be taken so that objects do not fall and liquids are not spilled into any openings or vents located on the product.

8. Attachments

Do not use attachments not recommended by the product manufacturer.

9. Lightning and Power Surge Protection

Unplug the unit from the wall outlet and disconnect during these periods of time. This will prevent damage to the product due to lightning and power-line surges.

10.Overloading

Do not overload wall outlets, extension cords, or integral convenience receptacles as this can result in a risk of fire or electric shock.

11.Damage Requiring Service

This unit should be serviced by qualified service personnel when:

A.The power supply cord or plug has been damaged.

B.Objects have fallen into or liquid has been spilled into the enclosure.

C.The unit has been exposed to rain.

D.The unit has been dropped or the enclosure damaged.

E.The unit exhibits a marked change in performance or does not operate normally.

12.Antenna

Do not connect an external antenna to the unit (other than that provided).

13.Periods of Nonuse

If the unit is to be left unused for an extended period of time, such as a month or longer, the power cord should be unplugged from the unit to prevent damage or corrosion.

14.Servicing

The user should not attempt to service the unit beyond those methods described in the user's operating instructions. Service methods not covered in the operating instructions should be referred to a qualified service personnel.

COMPLIANCE WITH FCC REGULATIONS

This device complies with Part 15 of the FCC Rules. Operation is subject to the following two conditions:

(1) This device may not cause harmful interference, and (2) this device must accept any interference received, including interference that may cause undesired operation.

In accordance with FCC requirements, changes or modifications to this unit not expressly approved by the party responsible for compliance could void the user's authority to operate the equipment.

NOTE:

This equipment has been tested and found to comply with the limits for a Class B Digital Device, pursuant to Part 15 of the FCC Rules. These limits are designed to provide reasonable protection against harmful interference in a residential installation. This equipment generates, uses and can radiate radio frequency energy and, if not installed and used in accordance with the instructions, may cause harmful interference to radio communications. However, there is no guarantee that interference will not occur in a particular installation. If this equipment does cause harmful interference to radio or television reception, which can be determined by turning the equipment off and on, the user is encouraged to try to correct the interference by one or more of the following measures:

- Reorient or relocate the receiving antenna.
- Increase the separation between the equipment and receiver.
- Connect the equipment into an outlet on a circuit different from that to which the receiver is connected.
- Consult the dealer or an experienced radio/TV technician for assistance.

CAUTION:

Changes or modifications not expressly approved by the party responsible for compliance could void the user's authority to operate the equipment.

PRODUCT FEATURES

JiMS-125 is an iPod Docking Music System which incorporates the following features :

- iPod , iPod mini, iPod classic, iPod touch and iPod nano Player / Re-charger
- AM / FM Stereo receiver with digital read out on LCD
- Audio line-in for connecting other digital audio player
- Clock and Alarm timer function
- Wake up to Alarm (Buzzer), iPod or Radio with Snooze function
- Built-in 2 High Fidelity Speakers
- Attached FM Antenna wire for better radio reception
- Stereo Headphone jack connection for private listening

INSTALLATION

Clock setting battery back-up

The battery back-up compartment is located on the back of the unit.

- (1) Remove the battery compartment door.
- (2) Follow the polarity diagram shown inside the compartment and install 2 x AAA batteries (not included).
- (3) Replace the battery compartment door.

WARNING:

- Be sure that the batteries are installed correctly. Wrong polarity may damage the unit.
- Do not mix old and new batteries.
- Do not mix alkaline, standard (carbon-zinc) or rechargeable (nickel-cadmium) batteries.
- Only batteries of the same or equivalent type as recommended are to be used.
- If the unit is not to be used for an extended period of time, remove the battery.
- Do not dispose of batteries in fire, batteries may explode or leak.

AC-DC Adaptor Connection

The unit is powered by an external AC-DC Power Adaptor with an output of 10VDC 1000mA (included).



- (1) Firmly and securely plug the adaptor's AC plug into AC main outlet.
- (2) Insert the adaptor's DC output plug into the DC -IN jack on the back of the unit.

NOTE: This unit is not magnetically shielded and may cause color distortion on the screen of some TVs or video monitors. To avoid this, you may need to move the unit further away from the TV or monitor if unnatural color shifts or image distortion occurs.

LOCATION OF CONTROLS

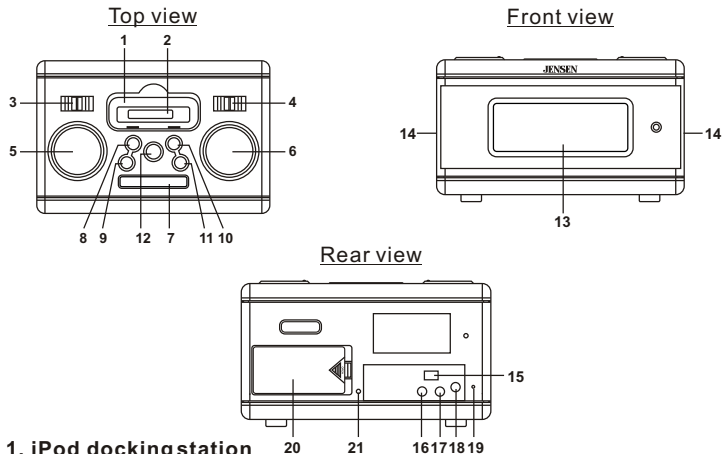
Main Unit



- 1. iPod docking station**
- 2. iPod docking connector**
- 3. Function switch** : Power Off ; select RADIO / iPOD / AUX modes.
- 4. Band switch** : Select between FM STEREO / FM (mono) / AM
- 5. VOLUME knob** : Adjusts the volume level up or down.
- 6. TUNING knob** : Adjusts the radio channel frequency up or down.
- 7. SNOOZE button** : Activate the snooze function.
- 8. TIME SET**  button : Select clock setting mode; iPod play/pause.
- 9. ALARM SET**  button : Select alarm time setting mode.
- 10. ▲ Button** : Set Hour value of Clock and Alarm time; In iPod mode, skip tracks or perform high-speed search forward.
- 11. ▼ Button** : Set Minute value of Clock and Alarm time; In iPod mode, skip tracks or perform high-speed search backward.
- 12. ALARM ON / OFF button** : Switch the alarm on or off.
- 13. LCD display**
- 14. Pair of Speakers**
- 15. ALARM wake to switch**: Alarm source Buzzer / iPod / Radio selection
- 16. AUX IN jack** : Auxiliary audio signal input
- 17. Phones Jack**

18. **DC-in jack** : For the connection of external DC power supply
19. **FM Antenna wire**
20. **Battery Compartment**
21. **RESET** button : Reset the unit.

LOCATION OF CONTROLS

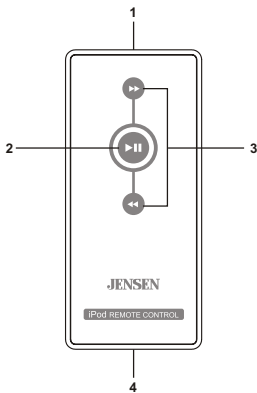

Remote Control (for iPod only)



1. **Infra-red Transmitter**
2. iPod **PLAY / PAUSE** ►/|| button
3. ►► / ◀◀ button ----- In iPod mode, skip tracks or perform high-speed search.
4. **Battery Compartment**





CLOCK SETTING

Setting Clock Time

1. With the unit powered off, press & hold the **TIME SET**  button then press the **▲** (HOUR) / **▼** (MINUTE) buttons to adjust the clock time.
2. After the clock time is set, release the **TIME SET**  button.

ALARM OPERATIONS

Setting Alarm Time

1. With the unit powered off, press & hold the **ALARM SET**  button to display Alarm time, the alarm indicator  flashes on LCD; then press the **▲** (HOUR) / **▼** (MINUTE) buttons to set the alarm time.
2. After the alarm time is set, release the **ALARM SET**  button.
3. Slide the **ALARM** wake to switch to select desired alarm sound source.
 - (a) Wake to Buzzer ;
 - (b) Wake to iPod ----- Ensure the iPod is docked. Select the song or playlist you wish to be woken up to.
 - (c) Wake to Radio ----- Ensure the desired radio channel is tuned.
4. Press the **ALARM ON / OFF** button to enable the alarm function. The alarm indicator  stays on LCD display.
5. If you selected "Wake to iPod" or "Wake to Radio".
Adjust to a desired alarm volume level by rotating the **VOLUME** knob.

Wake to Buzzer

When the desired alarm time is reached, the Buzzer will sound for one hour.

Wake to iPod

When the desired alarm time is reached, the iPod will begin playing for one hour.

Wake to Radio

If the **BAND** switch is set to FM or AM mode then the radio will turn on and play for one hour when the desired alarm time is reached.

Caution:

The clock and alarm settings may be affected/lost if the AC adaptor is unplugged or if you experience a power outage. Please make sure to check both clock and alarm time settings if the power to the unit is interrupted at any time and reset if necessary.

Snooze Function

- You can activate the Snooze function manually after the alarm sounds by pressing the **SNOOZE** button once. Alarm will sound again in 5 minutes and snooze can be manually activated again within 1 hour from the original wake time.
- After the alarm sounds you can also press the **ALARM ON / OFF** button to stop it immediately. The alarm will activate again once the preset alarm time is reached the next day.

Note: Your iPod must be properly docked in order for the wake to iPod function to work properly.

RADIO OPERATIONS

Radio Operation

Unwrap and fully extend the FM Antenna wire for the best reception.

1. Slide the **FUNCTION** switch to RADIO mode.
2. Slide the **BAND** switch to select FM Stereo / FM or AM band.
3. Rotate the **TUNING** knob and tune to a desired station.
4. Adjust the sound level by rotating the **VOLUME** knob.

NOTE: *The iPod may cause interference to the AM reception if it is docked and turned ON.*

You should turn off the iPod manually or remove it from the unit for better reception.

Tips for the Best Reception

To obtain the best AM reception, slightly rotate the unit until the clearest signal is received or place it near a window.

To obtain the best FM reception, fully extend the FM Antenna and adjust its direction.

iPod DOCKING

If the docking port will not be used for an extended period of time, it is recommended to cover the docking port by using the "Dock Cover" insert (included).

1. Use the iPod adaptor included in your iPod and insert it into the docking area. Your iPod can now be inserted into the docking port by placing the connector on the bottom of the iPod onto the connector in the docking bay.
2. Insert your iPod with its Connector faced downward and directly over the Dock connector on the unit.

Note: Please be careful when seating the iPod into the docking to avoid damaging the 30-pin connector on the iPod or in the docking system.

3. Slide the **FUNCTION** switch to select IPOD mode. The iPod will start playing automatically and starts charging immediately.
4. Press the **PLAY/PAUSE** ►/II button to pause or resume iPod playback.
5. Rotate the **VOLUME** knob on this unit to adjust your desired volume level.

Note : The Volume level cannot be adjusted by the volume control of your iPod after being docked.

6. Your iPod is charging even during playback.
Note: The recharge function operates in iPod and AUX mode only.
7. To remove the iPod from the unit, press and hold the PLAY/PAUSE button for three seconds to switch off the device and then gently remove it from the docking connector.

iPod playback control:

- Press the PLAY/PAUSE ►/II button to pause or resume the iPod playback;
- Press the iPod Skip/Search Forward ►► or Backward ◀◀ button to skip to the next or previous song;
- Press and hold the iPod Skip/Search Forward ►► or Backward ◀◀ button for fast-forwarding or fast-rewinding during playback.

AUXILIARY INPUT

The unit provides the auxiliary audio signal input for the connection of an external audio device. You may connect an audio cable with 3.5 mm stereo plug (not included) to the **AUX IN Jack** located at rear of the unit. Connect the other end of the cable to a Line Out Jack or Headphone Jack of your non-dockable MP3 player, CD player and other, non-dockable iPods then listen to your external source through the speakers of this system.

1. Connect an audio cable with 3.5 mm stereo plug to the **AUX IN Jack** located at rear of the unit.
2. Connect the other end of the cable to a Line Out Jack or Headphone Jack of your external audio device.
3. Turn on the external audio device.
4. To select auxiliary audio input, slide the **FUNCTION** switch to AUX position.
5. The volume level can now be controlled through the main unit.
Operate all other functions on the auxiliary device as usual.

NOTE:

- (1) If you connected the Line Out Jack of your external device then you only need to adjust the volume control of this unit. If you connected the Headphone Jack of your external device then you may need to adjust both the volume control of your external device and the volume control of this unit to find the most desirable volume setting.
- (2) Slide the **FUNCTION** switch to OFF position turning off the unit when you finish listening.
Don't forget to switch off the power of your external device as well.

CARE AND MAINTENANCE

- Do not subject the unit to excessive force, shock, dust or extreme temperature.
- Do not tamper with the unit's internal components.
- Clean your unit with a damp (never wet) cloth. Solvents or detergents should never be used.
- Avoid leaving your unit in direct sunlight or in hot, humid or dusty places.
- Keep your unit away from heating appliances and sources of electrical noise such as fluorescent lamps or motors.

Resetting the Unit

If the unit is subjected to a severe power surge or electric shock, it is possible that the internal microcontroller may “lock up” and the unit will not respond to any commands from the top panel controls.

1. In this event, unplug and then reconnect the AC power plug into the wall outlet.
2. Use a straightened paper clip, toothpick, or similar blunt object to press the **RESET** button located at rear of the main unit (see figure below).
The reset operation clears the system memory and all of your previous settings will be erased.

Caution: DO NOT use a sharp, pointed object to press the RESET button. It may damage the reset switch inside the unit.

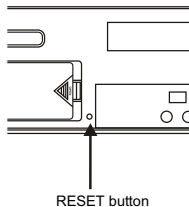

TROUBLESHOOTING GUIDE

Symptom	Possible Problem	Solution
The unit does not respond (no power)	AC Adaptor is not plugged into a wall outlet or the connector is not plugged into the power supply jack on the back of the unit.	Plug the AC adaptor into a wall outlet and plug the connector into the supply jack on the unit.
	Wall outlet is not functioning.	Plug another device into the same outlet to confirm the outlet is working.
iPod does not dock properly	Using no/wrong iPod Adaptor.	Make sure the dock insert is the proper fit for your iPod.
	iPod does not install properly.	Remove your iPod from the dock and check for obstruction on the connectors in the dock and on your iPod. Then reset it in the dock.
iPod does not respond to the speaker system	iPod is not installed properly.	Remove your iPod from the dock and check for obstruction on the connectors in the dock and on your iPod. Then reset it on the dock.
	Your iPod is locked up.	Please make sure that your iPod is working properly before docking into the unit. Please refer to your iPod manual for details.
iPod does not charge up	iPod is not installed properly.	Remove your iPod from the dock and check for obstruction on the connectors in the dock and on your iPod. Then reset it in the dock.
	iPod is locked up/ frozen. iPod battery has problem.	Please make sure your iPod is working properly before docking into the unit. Please refer to your iPod manual for details.
AM band is too noisy	The reception at the set location is poor.	Slightly rotate the unit for the best reception.
Sound is distorted	Volume level is set too high.	Decrease the volume.
	Sound source is distorted.	If the iPod original sound source is of poor quality, distortion and noise are easily noticed with high-power speakers. Try a different audio source such as a music CD. If you are using an external sound source like older generation of iPod, try reducing the output volume on the device itself. Also try turning bass boost OFF or change the EQ setting.
Unit gets warm after extended play at high volume	This is normal.	Turn the unit off for a period of time or lower volume.

SPECIFICATIONS

Power Requirement

Main unit

DC input: DC10V, 1000mA
Battery back up for clock: 2X DC1.5V 'AAA'(UM-4) Batteries

Remote Control 1X CR2032 Lithium Battery

Frequency Range

Radio

AM 530 -1710 kHz
FM 88 -108 MHz

SERVICE

Please refer to the instructions on the enclosed warranty card for returning your unit for service. When returning the unit, please remove batteries to prevent damage to the unit in transit and/or from possible leakage. We are not responsible for batteries returned with the product or for the cost of replacement.

Distributed by:
SPECTRA Merchandising International, Inc.
Chicago Industry Tech Park
4230 North Normandy Avenue
Chicago, IL 60634, U.S.A.

Please have model number ready, for Customer Service, call 1-800-777-5331.

The specification and external appearance of the set are subject to change without prior notice.