

Studebaker

Master Blaster Bluetooth Boombox

with CD Player, AM/FM Stereo Radio,
CD/USB MP3 Playback, 10 Watts RMS output,
3-way Power Operation (AC/DC/Car-Boat adaptor)

SB2149 OWNER'S MANUAL



BC

Please read this Instruction Manual carefully before using
the unit and retain it for future reference

WARNING

TO PREVENT FIRE OR SHOCK HAZARD, DO NOT USE THIS PLUG WITH AN EXTENSION CORD, RECEPTACLE OR OTHER OUTLET UNLESS THE BLADES CAN BE FULLY INSERTED TO PREVENT BLADE EXPOSURE. TO PREVENT FIRE OR SHOCK HAZARD, DO NOT EXPOSE THIS APPLIANCE TO RAIN OR MOISTURE.

 <p>The lightning flash with arrowhead symbol, within an equilateral triangle is intended to alert the user to the presence of uninsulated dangerous voltage within the product is enclosure that may be of sufficient magnitude to constitute a risk of electric shock to persons.</p>	<p>CAUTION RISK OF ELECTRIC SHOCK DO NOT OPEN</p> <p>CAUTION TO REDUCE THE RISK OF ELECTRIC SHOCK, DO NOT REMOVE COVER (OR BACK). NO USER-SERVICEABLE PARTS INSIDE. REFER SERVICING TO QUALIFIED SERVICE PERSONEL.</p>	 <p>The exclamation point within an equilateral triangle is intended to alert the user to the presence of important operating and maintenance (servicing) instructions in the literature accompanying the appliance.</p>
--	---	---

The Caution Marking is located at the back enclosure of the apparatus.

The Rating plate is located at the back enclosure of the apparatus

IMPORTANT SAFETY INSTRUCTIONS

1. Read these instructions.
2. Keep these instructions.
3. Heed all warnings.
4. Follow all instructions.
5. Do not use this apparatus near water.
6. Clean only with dry cloth.
7. Do not block any ventilation openings. Install in accordance with the manufacturer's instructions.
8. Do not install near any heat sources such as radiators, heat registers, stoves, or other apparatus (including amplifiers) that product heat.
9. Do not defeat the safety purpose of the polarized or grounding-type plug. A polarized plug has two blades with one wider than the other. A grounding type plug has two blades and a third grounding prong. The wide blade or the third prong is provided for your safety. If the provided plug does not fit into your outlet, consult an electrician for replacement of the obsolete outlet.
10. Protect the power cord from being walked on or pinched particularly at plugs, convenience receptacles, and the point where they exit from the apparatus.
11. Only use attachments/accessories specified by the manufacturer.
12. Use only with a cart, stand, tripod, bracket, or table recommended by the manufacturer, or sold with the product. When a cart is used, use caution when moving the cart/apparatus combination to avoid injury from tip-over.
13. Unplug this apparatus during lightning storms or when unused for a long period of time.
14. Refer all servicing to qualified service personnel. Servicing is required when the apparatus has been damaged in any way, such as power-supply cord or plug is damaged, liquid has been spilled or objects have fallen into the apparatus, the apparatus has been exposed to rain or moisture, does not operate normally, or has been dropped.
15. This appliance shall not be exposed to dripping or splashing water and that no object filled with liquids such as vases shall be placed on the apparatus



16. Do not overload wall outlet. Use only power source as indicated.
17. Use replacement part as specified by the manufacturer.
18. Upon completion of any service or repairs to this product, ask the service technician to perform safety checks.
19. Power Sources - This product should be operated only from the type of power source indicated on the marking label. If you are not sure of the type of power supply to your home, consult your product dealer or local power company. For products intended to operate from battery power, or other sources, refer to the operating instruction.
20. Object and Liquid Entry - Never push objects of any kind into this product through openings as they may touch dangerous voltage points or short-out parts that could result in a fire or electric shock. Never spill liquid of any kind on the product.
21. Damage Requiring Service - Unplug this product from the wall outlet and refer servicing to qualified service personnel under the following conditions:
 - a) When the power-supply cord or plug is damaged,
 - b) If liquid has been spilled, or objects have fallen into the product,
 - c) If the product has been exposed to rain or water,
 - d) If the product does not operate normally by following the operating instructions. Adjust only those controls that are covered by the operating instructions as an improper adjustment of other controls may result in damage and will often require extensive work by a qualified technician to restore the product to its normal operation.
 - e) If the product has been dropped or damaged in any way, and
 - f) When the product exhibits a distinct change in performance - this indicates a need for service.
22. Mains plug is used as disconnect device and it should remain readily operable during intended use. In order to disconnect the apparatus from the mains completely, the mains plug should be disconnected from the mains socket outlet completely.
23. Battery shall not be exposed to excessive heat such as sunshine, fire or the like.
24. Excessive sound pressure from earphones and headphone can cause hearing loss.
25. Minimum distances of 4 inches around the apparatus for sufficient ventilation.
26. The ventilation should not be impeded by covering the ventilation openings with items, such as newspapers, table-cloths, curtains, etc.
27. No naked flame sources, such as lighted candles, should be placed on the apparatus.
28. The use of apparatus in moderate climates.
29. Attention should be drawn to the environmental aspects of battery disposal.

SAVE THESE INSTRUCTIONS

COMPLIANCE WITH FCC REGULATIONS

FCC ID: 2ANH76961401USB

This device complies with Part 15 of the FCC Rules. Operation is subject to the following two conditions:

- (1) This device may not cause harmful interference, and
- (2) This device must accept any interference received, including interference that may cause undesired operation.

This equipment has been tested and found to comply with the limits for a Class B Digital Device, pursuant to Part 15 of the FCC Rules. These limits are designed to provide reasonable protection against harmful interference in a residential installation. This equipment generates, uses and can radiate radio frequency energy and, if not installed and used in accordance with the instructions, may cause harmful interference to radio communications. However, there is no guarantee that interference will not occur in a particular installation. If this equipment does cause harmful interference to radio or television reception, which can be determined by turning the equipment off and on, the user is encouraged to try to correct the interference by one or more of the following measures:

- Reorient or relocate the receiving antenna.
- Increase the separation between the equipment and receiver.
- Connect the equipment into an outlet on a circuit different from that to which the receiver is connected.
- Consult the dealer or an experienced radio/TV technician for help.

WARNING

Changes or modifications to this unit not expressly approved by the party responsible for compliance could void the user's authority to operate the equipment.

CAUTION

CLASS 1 LASER PRODUCT

CLASS 1 LASER PRODUCT
APPAREIL LASER DE CLASSE 1
PRODUCTO LASER DE CLASE 1

CAUTION
INVISIBLE LASER RADIATION
WHEN OPEN AND INTERLOCKS
DEFEATED.
AVOID EXPOSURE TO BEAM



This product contains a low power laser device.

Follow the advice below for safe operations.

ON PROTECTION AGAINST LASER ENERGY EXPOSURE

- As the laser beam used in this compact disc player is harmful to the eyes, do not attempt to disassemble the casing.
- Stop operation immediately if any liquid or solid object should fall into the cabinet.
- Do not touch the lens or poke at it. If you do, you may damage the lens and the player may not operate properly.
- Do not put anything in the safety slot. If you do, the laser diode will be ON when the CD door is still open.
- If the unit is not to be used for a long period of time, make sure that all power sources are disconnected from the unit. Remove all batteries from the battery compartment.
- This unit employs a laser. The use of controls or adjustment or performance of procedures other than those specified here may result in exposure to hazardous radiation.

Caution:

- Any use of the controls or performing any of the procedures in a way other than those specified herein may result in hazardous radiation exposure.
- This unit should not be adjusted or repaired by anyone except qualified service personnel.

ON PLACEMENT

- Do not use the unit in places which are extremely hot, cold, dusty or humid.
- Place the unit on a flat and even surface.
- Do not restrict the air-flow of the unit by placing it in a place with poor ventilation, by covering it with a cloth or by placing it on a carpet.

ON CONDENSATION

- When left in a heated room where it is warm and damp, water droplets or condensation may form inside the unit.
- When there is condensation inside the unit, the unit may not function normally. Let it stand for 1 to 2 hours before turning the power on, or gradually heat the room up and dry the unit before use.

Should any trouble occur, disconnect the AC Adapter and refer servicing to qualified personnel.

PROTECT YOUR FURNITURE

This system is equipped with non-skid rubber 'feet' to prevent the product from moving when you operate the controls. These 'feet' are made from non-migrating rubber material specially formulated to avoid leaving any marks or stains on your furniture. However certain types of oil based furniture polishes, wood preservatives, or cleaning sprays may cause the rubber 'feet' to soften, and leave marks or a rubber residue on the furniture.

To prevent any damage to your furniture we strongly recommend that you purchase small self-adhesive felt pads, available at hardware stores and home improvement centers everywhere and apply these pads to the bottom of the rubber 'feet' before you place the product on fine wooden furniture.

DEAR STUDEBAKER® CUSTOMER

Selecting fine audio equipment such as the unit you've just purchased is only the start of your musical enjoyment. Now it's time to consider how you can maximize the fun and excitement your equipment offers. This manufacturer and the Electronic Industries Association's Consumer Electronics Group want you to get the most out of your equipment by playing it at a safe level. One that lets the sound come through loud and clear without annoying blaring or distortion and, most importantly, without affecting your sensitive hearing. Sound can be deceiving. Over time your hearing "comfort level" adapts to higher volumes of sound. So what sounds "normal" can actually be loud and harmful to your hearing. Guard against this by setting your equipment at a safe level BEFORE your hearing adapts.

To establish a safe level:

- Start your volume control at a low setting.
- Slowly increase the sound until you can hear it comfortably and clearly, and without distortion.

Once you have established a comfortable sound level:

- Set the dial and leave it there.

Taking a minute to do this now will help to prevent hearing damage or loss in the future. After all, we want you listening for a lifetime.

We Want You Listening For a Lifetime

Used wisely, your new sound equipment will provide a lifetime of fun and enjoyment. Since hearing damage from loud noise is often undetectable until it is too late, this manufacturer and the Electronic Industries Association's Consumer Electronics Group recommend you avoid prolonged exposure to excessive noise.



Customer's Record:

The serial number of this product is found on its back cover. You should note the serial number of this unit in the space provided as a permanent record of your purchase to aid in identification in the event of theft of loss.

Model Number: SB2149

Serial Number: _____

CONTENTS OF YOUR PRODUCT

- | | |
|---|-----|
| ● Main Unit | X 1 |
| ● AC adaptor (DC  12V 1.5A ) | X 1 |
| ● Car-Boat Adaptor | X 1 |
| ● User Manual | X 1 |

LOCATION OF CONTROLS

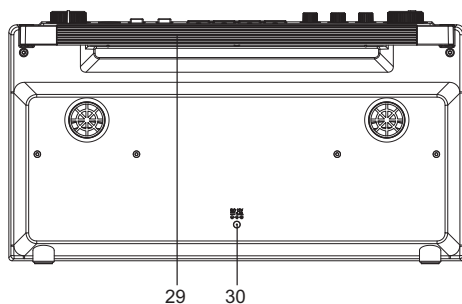
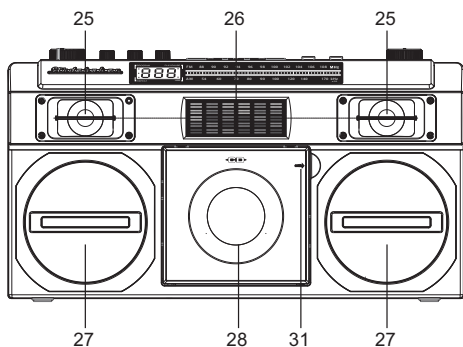
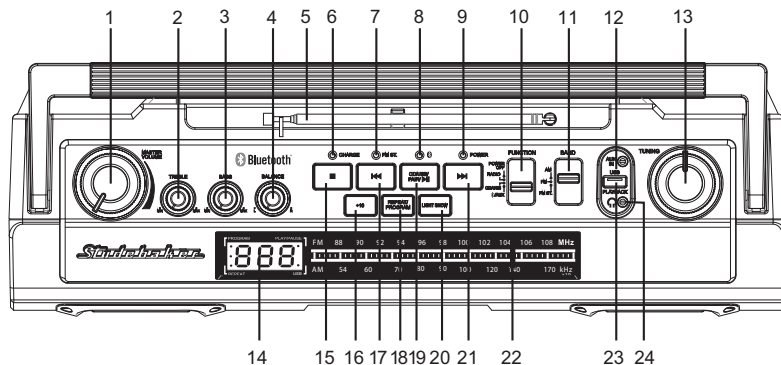

1	MASTER VOLUME	17	⏮ SKIP/FAST BACKWARD BUTTON
2	TREBLE KNOB	18	REPEAT/PROGRAM BUTTON
3	BASS KNOB	19	CD/USB MODE; PLAY/PAUSE ▶ ; BLUETOOTH PAIR BUTTON
4	BALANCE KNOB		
5	FM TELESCOPIC ANTENNA	20	LIGHT SHOW BUTTON
6	CHARGE INDICATOR	21	▶▶ SKIP/FAST FORWARD BUTTON
7	FM ST. INDICATOR	22	DIAL POINTER
8	BT INDICATOR	23	USB PORT
9	POWER INDICATOR	24	HEADPHONE JACK
10	FUNCTION SWITCH	25	TWEETER
11	BAND SWITCH	26	MULTI COLOR LIGHT SHOW LED
12	AUX IN JACK	27	WOOFER
13	TUNING KNOB	28	CD COMPARTMENT
14	LED DISPLAY	29	CARRYING HANDLE
15	STOP ■ BUTTON	30	DC INPUT JACK
16	+10 BUTTON	31	CD DOOR LATCH

POWER SOURCE

This unit can be operated using either AC power or the built-in Li-Polymer rechargeable battery

AC POWER OPERATION

An AC-DC Adaptor with the output of DC 12V, 1.5A (included) is required for operating the main unit when using AC power mode. To connect the AC-DC Adaptor to the unit and 120V~ 60Hz AC Outlet:

1. Firmly and securely insert the DC plug of the adaptor into the DC Jack on the back of the unit.
2. Plug the AC Adaptor plug into the 120V AC outlet. CHARGE LED will be lighting Red during battery charging. Connecting this system to any other power source may cause damage to the system
3. Slide the FUNCTION switch on the top panel to RADIO,CD/USB or BLUETOOTH/AUX mode to turn on the unit, the POWER INDICATOR will light.

Note: When the unit is not operated for long periods of time, unplug the AC adapter from the unit and wall outlet.

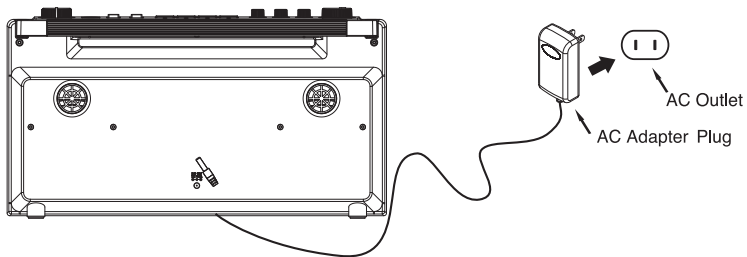

BUILT-IN RECHARGEABLE BATTERY OPERATION

1. This unit will also operate using the built-in Lithium rechargeable battery. Fully charge the built-in rechargeable battery before first use, the CHARGE INDICATOR will turn from Red to Green when the built-in battery is fully charged.
2. Unplug the DC INPUT jack of main unit. The unit will enter Battery Operating mode automatically.

LOW BATTERY INDICATION

1. When the build-in battery power remains around 5%, the CHARGE INDICATOR will light Red and flash, please connect the unit to AC adaptor for charging.
2. After prolonged use, the battery voltage may discharge and operation might become intermittent. When this happens, please recharge the internal battery.

CAR-BOAT ADAPTOR OPERATION

A Car-Boat Adaptor is required for operating the main unit when using DC 12V car battery power mode. To connect the Car-Boat Adaptor to your car:

1. Firmly and securely insert the DC plug of the adaptor into the DC Jack on the back of the unit.
2. Plug the Car-Boat Adaptor plug into the 12V DC outlet of your car battery. CHARGE LED will be lighting Red during battery charging. Connecting this unit to any other power source may cause damage to the system
3. Press the POWER button on the top panel to turn on the unit, the POWER INDICATOR will light.

Note: When the unit is not operated for long periods of time, unplug the Car-Boat Adaptor from the unit and your car.

CHARGING INSTRUCTIONS

CHARGING THE BATTERY WITH THE INCLUDED AC ADAPTOR

1. Charge the built-in Lithium battery a minimum of 5 hours prior to first use. Firmly and securely insert the DC plug of the adaptor into the DC Jack on the back of the unit.
2. Plug the AC Adaptor plug into the 120V AC outlet. Connecting this system to any other power source may cause damage to the system.
3. When the AC power is connected, the battery charging indicator will light solid Red showing that the internal battery is being charged.
4. After the battery is fully charged, the charging indicator will turn to solid Green.

Notes:

- 1.) Charging time will vary if you are listening to music while charging the internal battery. We recommend you place the unit in Power off mode during the charging process or until SB2149 batteries are fully charged.
- 2.) To prolong the life of a rechargeable battery, it is recommended to completely discharge it before fully charging it again.
- 3.) Rechargeable batteries need to be cycled for maximum performance and longer battery life. If you don't use the player that often, be sure to recharge the battery at least once a month in order to keep the internal battery working properly.

Battery Note and Care

- Do not burn or bury batteries.
- Do not puncture or crush.
- Do not disassemble.
- Recycle Lithium batteries. Do not dispose of in the trash.
- Use only chargers rated for Lithium cells. Be sure the charger's voltage and current settings are correct for the battery pack being charged.
- Charge batteries on a fireproof surface away from flammable items or liquids.
- Batteries should NEVER be left unattended while charging. Only adults should charge the batteries.
- Follow the manufacturer's instructions for charging the product and do not charge longer than recommended. Unplug the charger when the battery is charged or not in use.

NOTE: These speakers are not magnetically shielded and may cause color distortion on the screen of some TVs or video monitors. To avoid this, you may need to move the speakers further away from the TV or monitor if unnatural color shifts or image distortion occurs.

RADIO OPERATION

1. Slide the FUNCTION switch to RADIO position, the unit will be "On" and power LED indicator lights.
2. Select the desired FM mode by switching the FM/FM ST. BAND SELECTOR on unit top panel.
3. Tune to your desired station with the TUNING knob. If FM STEREO mode is selected and you tune to an FM Stereo station, the FM STEREO LED Indicator will light.
4. Adjust the MASTER VOLUME knob to obtain the desired sound level.

FM & FM-STEREO RECEPTION

- Set the BAND SELECTOR to "FM" position. Stations will now be received in MONO mode. When a FM station is weak or distorted, listening is usually improved by switching the band selector to the FM (mono) position.
- Set the band selector to "FM-ST" position to receive stereo broadcasts. The FM-Stereo LED indicator will light up to show a FM stereo station is detected.

TIPS FOR BEST RADIO RECEPTION

AM - The AM antenna is built inside the radio. If AM reception is weak, change the position of the unit until the internal antenna picks up the strongest signal.

FM - If a stereo broadcast program is being received, the FM STEREO INDICATOR will light. During FM Stereo reception, always keep the FM TELESCOPIC ANTENNA fully extended for best performance. However, if FM reception is weak, try repositioning the unit near an open window until you get the best reception.

CD OPERATION

PLEASE READ THIS IMPORTANT INFORMATION:

CD mechanisms used in devices like this are designed to fully read all commercial CDs. They will also read self-compiled CD-R/CD-RW discs but it may take up to 10 seconds for playback to start. If playback does not start, it is likely due to the quality of the CD-R/RW disc and/or the compatibility of the CD compilation software. Manufacturer is not responsible for the playback quality of CD-R/RW discs.

Do not attach a label or seal to either side of the CD-R/RW disc. It may cause a malfunction.

1. Slide the FUNCTION switch to CD/USB position. The display will show “- -” briefly. If no CD has been loaded in the CD compartment, LED display will change to show “no”.
2. Grip the “OPEN” mark on the CD Door and pull gently to open it.
3. Carefully load an audio CD with its label side OUTward in the CD compartment then gently close the CD door.
4. The player will start reading TOC of the disc, total number of tracks on the CD will appear on the LED DISPLAY after a few seconds.
5. Press the PLAY/PAUSE ►|| button to start playing.
6. Adjust the MASTER VOLUME knob to obtain the desired sound.
7. To temporarily stop playing, press the PLAY/PAUSE ►|| Button. The play/pause indicator will be flashing. To resume playing, press the PLAY/PAUSE ►|| Button again. The play/pause indicator will be solid on.
8. You can skip up or down to a specific track number by pressing the SKIP BACKWARD ◀◀ button or SKIP FORWARD ▶▶ button. The LED Display will indicate the correct track number selected.
9. To locate a particular section within a track, press and hold the ◀◀ / ▶▶ button until the section is found.
10. To stop playing, press the STOP ■ button
11. Slide the Function switch to POWER OFF position to off the unit after listening.

+10 button control

Press the +10 button once to advance the music search by increment of 10 tracks.

REPEAT MODE

Repeat 1

To repeat the current track, press the REPEAT BUTTON once, the REPEAT INDICATOR will flash in LED display. The track will continue to play until the repeat function is turned off.

Repeat All

To repeat all the tracks, press the REPEAT BUTTON twice, the REPEAT INDICATOR will be solid on. All the tracks on the disc will be played repeatedly.

To Cancel Repeat Function: Press the REPEAT BUTTON until REPEAT indicator goes off from LED display.

PROGRAM OPERATION

This function allows the tracks to be played in a programmed sequence.

NOTE: Programs can only be set in STOP mode.

1. In CD stop mode, press REPEAT/PROGRAM button, the PROG indicator will light and Program Number "P01" will show on LED display.
2. Press the SKIP ◀◀ or ▶▶ button to select the desired track. The track number "1" (001 for MP3 CD) will blink on the LED display to prompt for input.
3. Press the PROGRAM button to confirm the selection. Program Number advances to "P02".
4. Repeat step 2 to 3 to program up to maximum of 20 tracks.
5. When maximum of 20 tracks have been programmed, the LED display will show "FUL" to indicate program is full.
6. When you have completed programming, press the PLAY/PAUSE ▶▶ button to start playing. Both PROG and Play/Pause indicators are lighting steadily.
7. To cancel programmed play, press the STOP ■ button twice. PROG indicator goes off.

USING TREBLE/BASS/BALANCE CONTROL KNOBS

- **TREBLE:** Adjust TREBLE level of music playback.
- **BASS :** Adjust BASS level of music playback.
- **BALANCE :** Adjust BALANCE for balance left and right speaker.

USB OPERATION

The unit is designed to play MP3 files stored in the USB flash-drive. If the files on the USB device do not conform to the standard, they may not be played.

1. Slide the FUNCTION switch to CD/USB position. Press and hold the CD/USB/PAIR/ ▶▶ button until USB mode indication "USB" shows on LED display and USB indicator flashing.
2. Insert your USB flash-drive into the USB port, unit starts to read the USB flash-drive.

Notes:

- 1.) USB supports flash drive capacity up to 32 GB maximum.
 - 2.) Due to various USB flash drives in the market, please always fold down the carrying handle before insert USB flash drive into the USB port.
 - 3.) When carrying this unit, be sure your USB flash drive is not taller than the space under the carrying handle to avoid damaging.
3. After reading the USB flash-drive, the unit will display the total number of files on the flash-drive.

USB playback

After reading the USB flash-drive, press the PLAY/PAUSE ▶▶ button once, the first track/file on the USB flash-drive will be played back. The "USB" and "PLAY/PAUSE" indicators will be solid on during playback.

Play/Pause Control

To temporarily stop playing, press the ▶▶ button, music playback will be paused and the PLAY/PAUSE indicator will be blinking. Press the ▶▶ button again to resume playback.

Stop playback

To stop playback, press the STOP ■ button on the unit. The total number of tracks/files on the USB flash-drive will be shown on the LED display.

Skip track

During playback, press the SKIP backward ◀◀ or forward ▶▶ buttons to skip to the previous or next track/file.

+10 control

Press the +10 button to advance the music search by increments of 10 tracks.

REPEAT MODE

Repeat 1

To repeat the current track, press the REPEAT/PROGRAM BUTTON once, the REPEAT INDICATOR will flash in LED display. The track will continue to play until the repeat function is turned off.

Repeat All

To repeat all the tracks, press the REPEAT BUTTON twice, the REPEAT INDICATOR will be solid on. All the tracks on the disc will be played repeatedly.

To Cancel Repeat Function: Press the REPEAT BUTTON until REPEAT indicator goes off from LED display.

Programmed USB playback



This unit can be programmed to play up to 20 tracks/files in USB mode.





1. Plugged in your flash-drive into USB port, make sure unit is in stop mode.
2. Press REPEAT/PROGRAM button, the PROGRAM Indicator will light and program Channel Number "P01" will show on the LED DISPLAY.
3. Press ◀◀ or ▶▶ button to select the track to be programmed. The track number "001" will blink on the LED DISPLAY to prompt for input.
4. Press the PROGRAM button again to store selection. The Program Channel Number will change to "P02".
5. You may repeat steps 2 - 3 to program as many as 20 tracks. When the memory full, "FUL" will show on the LED DISPLAY.
6. Press the PLAY/PAUSE ▶|| button to start the programmed play.
7. Press STOP ■ button once to stop playback.
8. Press the ▶|| button to resume programmed play.
9. To cancel programmed play, press the STOP ■ button twice.

BLUETOOTH OPERATION

PAIRING A SMARTPHONE OR BLUETOOTH ENABLED DEVICE

The Bluetooth feature enables you to stream and play the digital music on your Bluetooth enabled device to your unit. (make sure AUX IN jack is no plug in AUX cable)

1. Slide the FUNCTION switch to Bluetooth  /AUX position, the Bluetooth  indicator will flash.
2. The unit will start in auto connection mode and search for a previously paired device that is active and in range (30 feet/10 meters). If found, a brief welcome melody will be heard and Bluetooth indicator will change to solid on. If no active device is found, the unit will switch to interactive pairing mode and the Bluetooth indicator keeps flashing.
3. To establish a new link, turn on the Bluetooth function of your Bluetooth enabled device and enable the search or scan feature to find "SB2149" in the list of discoverable Bluetooth devices. Select the "SB2149" from your available device list when it appears on its screen and a brief welcome melody will be heard if pairing and connection is successful. If you are asked for a password, enter "0000".
4. If no successful pairing and connection is made within 5 minutes, the unit can enter manual pairing mode. You need to press and hold the PAIR button until Bluetooth indicator flashes to initiate a pairing/connecting request to a new or old Bluetooth enabled device. Follow step #3 to complete the process.

5. After successfully pairing and connecting your device with SB2149, the unit will emit a brief welcome melody and the Bluetooth indicator will change to solid on. You can now play music from your Bluetooth enabled device wirelessly to the SB2149.
6. If you want to connect the SB2149 to another new external Bluetooth enabled device while paired with another device, press and hold the PAIR  button for few seconds to disconnect the existing connection. The unit will emit two short beeps and Bluetooth indicator will change to flash. Repeat steps #3 to #4 above to make a new link.
7. Rotate the VOLUME CONTROL on the top panel to increase the listening volume gradually until a comfortable listening level is reached.
8. Press the PLAY/PAUSE  BUTTON to control play/pause.
9. Press the SKIP FORWARD  BUTTON to skip to next song and SKIP BACKWARD  BUTTON to skip to previous song.

Notes:

- If you cannot pair the unit with your Bluetooth enabled device, try solving the problem by turning the unit power off, then power on, and then starting the pairing process again.
- The Bluetooth function of the unit will remain paired unless the paired device goes out of range of 30 feet (10 meters). If the broken link is re-established within 20 seconds, the SB2149 will reconnect to the current paired device automatically. Otherwise you will need to make a manual connection again later.
- You may need to turn off the Bluetooth function of the paired external device first before make a new link.
- Refer to manual of your smartphone or external Bluetooth enabled device for correct Bluetooth operation instructions since it may vary from model to model.
- If your Bluetooth enabled device does not support A2DP, it will not play the music through the SB2149 system even after it is paired and connected successfully.
- If you are pairing and connecting your personal computer to the SB2149 using Bluetooth, you may need to set the SB2149 as your computer's default sound device.

RE-LINKING TO A SMARTPHONE OR BLUETOOTH ENABLED DEVICE

Even if your smartphone or Bluetooth device is already paired with the SB2149 and with both Bluetooth functions turned on, they can become unlinked at some point due to intentional manual disconnection or undesirable external signal interferences or over-range for more than 10 seconds. If this happens, the unit will emit two short beeps. You can re-link them and resume play by:

1. Select "SB2149" from the device list on your smartphone or Bluetooth device. The SB2149 should re-link to your Bluetooth enabled device within 5 seconds.
2. Tap the play button of the music player on your Bluetooth enabled device to resume playback.

AUX IN OPERATION

You can play other music sources (iPod, MP3 or other digital audio players) through the speakers of the unit by connecting the AUX IN JACK to your external player's audio out jack or headphone jack.

1. Plug one end of a 3.5mm audio cable (not included) into the AUX IN JACK and the other end of the cable to the headphone jack of your digital audio player.
2. Slide the FUNCTION switch to the Bluetooth  /AUX position.
3. Turn on and start playing the external device you plugged into the AUX IN JACK.
4. Slowly adjust both the volume controls of your unit and the external device until you reach a comfortable listening level.
5. Turn off both the external audio player and this unit after use. Unplug the audio cable from AUX IN jack

Notes:

- If you connect the unit to the Line-Out Jack of your external device, you only need to adjust the VOLUME CONTROL of your unit. If you connect to the Headphone Jack of your external device, you may need to adjust both the volume controls of your external device and the unit to obtain the desirable listening level.
- Remember to turn off the unit when you have finished listening. Don't forget to switch off the power of your external audio device as well.

USE HEADPHONES (NOT INCLUDED)

Inserting the plug of your stereo headphones (not included) into the headphone jack located on the top panel will enable you to listen in private. When using headphones, the speakers will be disconnected.

Read this Important Information before Using Your Headphones

- 1.) Avoid extended play at very high volume as it may impair your hearing.
- 2.) If you experience ringing in your ears, reduce the volume or shut off the unit.
- 3.) Keep the volume at a reasonable level even if your headset is an open-air type designed to allow you to hear outside sounds. Please note that excessively high volume may still block outside sounds.

LED LIGHT SHOW

- To turn off the LED light show, press the LIGHT SHOW button.
- To turn on the LED light show, press the LIGHT SHOW button once again.

Note: If the brightness is glaring, turn on room lights or turn off LED light show.

RESETTING THE UNIT

In case of malfunction due to electrostatic discharge, reset the unit by slide the FUCTION switch to POWER OFF position to reset the unit. Wait for 30 seconds before power on the unit again.

CARE AND MAINTENANCE

1. Do not subject the unit to excessive force, shock, dust or extreme temperature.
2. Do not tamper the internal components of the unit.
3. Clean your unit with a dry cloth. Solvent or detergent should never be used.
4. Avoid leaving your unit in direct sunlight or in hot, humid or dusty places.
5. Keep your unit away from heating appliances and sources of electrical noise such as fluorescent lamps or motors.
6. If drop-outs or interruptions occur in the music during CD play, or if the CD fails to play at all, its bottom surface may require cleaning. Before playing, wipe the disc from the center outwards with a good soft cleaning cloth.

**CLEANING THE UNIT**

- To prevent fire or shock hazard, disconnect your unit from the AC power source when cleaning.
- The finish on the unit may be cleaned with a dust cloth and cared for as other furniture, Use caution when cleaning and wiping the plastic parts.
- If the cabinet becomes dusty wipe it with a soft dry dust cloth. Do not use any wax or polish sprays on the cabinet.
- If the front panel becomes dirty or smudged with fingerprints it may be cleaned with a soft cloth slightly dampened with a mild soap and water solution. Never use abrasive cloths or polishes as these will damage the finish of your unit.

CAUTION: Never allow any water or other liquids to get inside the unit while cleaning.

TROUBLE SHOOTING GUIDE

Symptom	Possible Cause	Solution
The unit does not respond (no power)	The unit is disconnected from the AC outlet.	Reconnect to the AC outlet.
	The AC outlet has not power.	Try the unit on another outlet.
Unit is ON but there is low or no volume	Volume set too low.	Slowly rotate the MASTER VOLUME knob to increase the volume level.
AM/FM no sound	Unit not in Radio mode.	Slide FUNCTION switch to select RADIO.
Bluetooth No Sound	Unit is not linked with your Bluetooth enabled device.	Go through "Bluetooth Operations" process to link the speakers.
	Unit placement out of range.	Relocate the unit within Bluetooth operating range (30 feet)
	Your Bluetooth enabled device Volume set too low.	Increase Volume level of your Bluetooth enabled device.
Noise or sound distorted on FM broadcast	Station not tuned properly.	Fine tune the FM broadcast station.
	FM: telescopic antenna is not fully extended.	Fully extend the FM telescopic antenna.
	AM: Internal antenna is not positioned correctly.	Reposition the unit until the best reception is obtained.
USB player will not play	Unit not in USB function mode.	Slide FUNCTION switch to CD/USB and long press the CD/USB/PAIR/▶ button until USB indicator is flashing.
	Can't read USB data	USB flash drive fault, change another good one.
CD player will not play	Unit not in CD function mode.	Slide FUNCTION switch to select CD.
	CD is installed incorrectly.	Insert CD with label side outward.
	If the CD is self-compiled, the media used may not be compatible with the player.	Use better quality blank media and retest.
CD skips while playing	Disc is dirty or scratched.	Wipe CD with clean cloth or use another disc.
Intermittent sound from CD Player	Dirty or defective disc.	Clean or replace the defective disc.
	Dirty pick up lens.	Use a CD-lens cleaning disc to clean the lens.
	Player is subject to excessive shock or vibration.	Relocate the player away from shock or vibration.
Sound is distorted	Volume level is set too high.	Decrease the volume.
	Sound source is distorted.	Try a different sound source. If you are using an external sound source like older generation of iPod, try reducing the output volume on the device itself. Also try turning bass boost OFF or change the EQ setting.
Unit gets warm after extended play at high volume	This is normal.	Turn the unit off for a period of time or lower volume

SPECIFICATION

Radio Frequency Range	: AM: 530 – 1710 KHz : FM: 88 – 108 MHz
Audio Output Power	: 2 X 5W (RMS)
Tweeter	: 2 x 1.5 inch / 6 ohms
Woofer	: 2 x 4 inch / 6 ohms
Bluetooth	: V4.2 + EDR
USB	: Support USB device up to 32GB

Power Source :

AC Adapter	: Input AC 120V~ 60Hz Output DC 12V  1.5A  
------------	---

Built-in Rechargeable Lithium Battery : DC 7.4V  , 2200mAh

Due to continuing improvement, the features and the design are subject to change without notice.



At Spectra, environmental and social responsibility is a core value of our business. We are dedicated to continuous implementation of responsible initiatives with an aim to conserve and maintain the environment through responsible recycling. Please visit us at <http://www.spectrainl.com/green.htm> for more information on Spectra's green initiatives or to find a recycler in your area.

The Bluetooth® word mark and logos are registered trademarks owned by Bluetooth SIG, Inc. and any use of such marks by Spectra Merchandising Intl, Inc. is under license. Other trademarks and trade names are those of their respective owners.

**90 DAY LIMITED WARRANTY AND SERVICE
VALID IN THE U.S.A. ONLY**

SPECTRA MERCHANDISING INTERNATIONAL, INC. warrants this unit to be free from defective materials or factory workmanship for a period of 90 days from the date of original customer purchase and provided the product is utilized within the U.S.A. This warranty is not assignable or transferable. Our obligation under this warranty is the repair or replacement of the defective unit or any part thereof, except batteries, when it is returned to the SPECTRA Service Department, accompanied by proof of the date of original consumer purchase, such as a duplicate copy of a sales receipt.

You must pay all shipping charges required to ship the product to SPECTRA for warranty service. If the product is repaired or replaced under warranty, the return charges will be at SPECTRA's expense. There are no other express warranties other than those stated herein.

This warranty is valid only in accordance with the conditions set forth below:

1. The warranty applies to the SPECTRA product only while:
 - a. It remains in the possession of the original purchaser and proof of purchase is demonstrated.
 - b. It has not been subjected to accident, misuse, abuse, improper service, usage outside the descriptions and warnings covered within the user manual or non-SPECTRA approved modifications.
 - c. Claims are made within the warranty period.
2. This warranty does not cover damage or equipment failure caused by electrical wiring not in compliance with electrical codes or SPECTRA user manual specifications, or failure to provide reasonable care and necessary maintenance as outlined in the user manual.
3. Warranty of all SPECTRA products applies to residential use only and is void when products are used in a nonresidential environment or installed outside the United States.

This warranty gives you specific legal rights, and you may also have other rights which vary from state to state. TO OBTAIN SERVICE please remove all batteries (if any) and pack the unit carefully and send it freight prepaid to SPECTRA at the address shown below. IF THE UNIT IS RETURNED WITHIN THE WARRANTY PERIOD shown above, please include a proof of purchase (dated cash register receipt) so that we may establish your eligibility for warranty service and repair of the unit without cost. Also include a note with a description explaining how the unit is defective. A customer service representative may need to contact you regarding the status of your repair, so please include your name, address, phone number and email address to expedite the process.

IF THE UNIT IS OUTSIDE THE WARRANTY PERIOD, please include a check for **\$70.00** to cover the cost of repair, handling and return postage. All out of warranty returns must be sent prepaid.

It is recommended that you contact SPECTRA first at 1-800-777-5331 or by email at custserv@spectraintrl.com for updated information on the unit requiring service. In some cases the model you have may be discontinued, and SPECTRA reserves the right to offer alternative options for repair or replacement.

SPECTRA MERCHANDISING INTERNATIONAL, INC.
4230 North Normandy Avenue,
Chicago, IL 60634, USA.
1-800-777-5331

To register your product, visit the link below to enter your information.
<http://www.spectraintrl.com/wform.htm>

0718

Printed in China